



Healthcare Supplies Catalog

Zebra has the right labels for hospital applications. Genuine Zebra labels are available in a range of sizes, materials and adhesives that can withstand all types of and storage requirements. Our labels are suitable for labeling all shapes and sizes of specimen containers, including test tubes, vials, microscope slides, petri dishes, and cassettes—plus pharmacy unit dose containers, including syringes and IV bags. Zebra even offers special blood bag labels that meet ISBT 128 compliance requirements.

Prices Effective March 9, 2020

Table of Contents

Lab

Cerner.....	3
MISYS/Sunquest.....	8
Meditech.....	8
Microscope Slide.....	9-10
General.....	11

ISBT 128.....	13
----------------------	-----------

Mobile Specimen Collection

Cerner, McKesson, Siemens.....	14
Meditech.....	16
IQ Color.....	18

Pharmacy

Cerner.....	19
General.....	20

Breast Milk Tracking

Cerner, McKesson, Siemens.....	21
CareFusion.....	22

Multipurpose.....	23
--------------------------	-----------

Specialty.....	26
-----------------------	-----------

Wristbands

Wristband Cartridges.....	29
Wristbands for Desktop and Industrial Printers.....	35
RFID Wristbands.....	42

Wristbands - Non Printable

Alert Solutions.....	44
OmniBand.....	47
Vinyl Infant Wristband Solutions.....	48
ComfyCuff Solutions.....	49

Ribbons.....	51
---------------------	-----------

Lab

Cerner

8000D Lab

A direct thermal paper label with a high-tack permanent acrylic adhesive specifically designed to adhere to small, curved, surfaces.

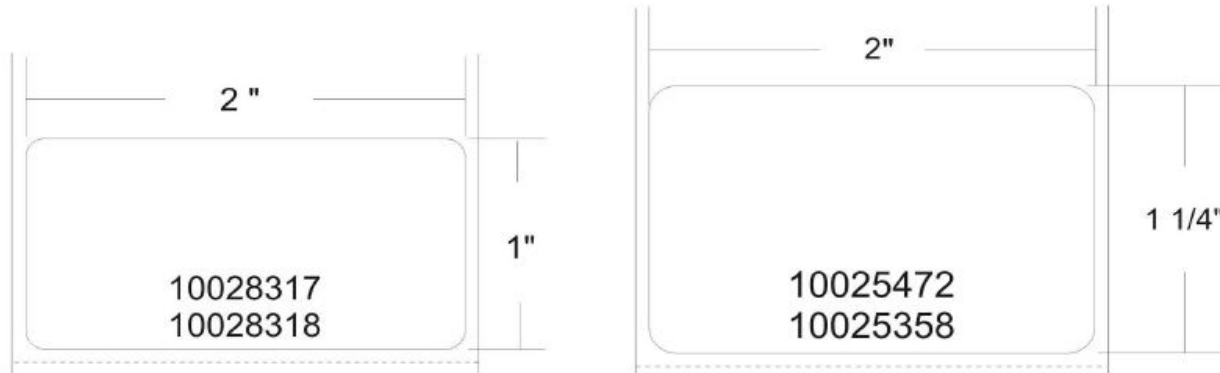

Size			Part #	ID, OD	Amount/ roll	Rolls/ carton	Stock/ MTO	Price/roll	Price/M
W	x	L							
2	x	1	10028317	3" ID, 8" OD	5,200	6	MTO	\$27.86	\$5.36
2	x	1	10028318	1" ID, 5" OD	2,330	6	MTO	\$15.81	\$6.79
2	x	1.25	10025472	3" ID, 8" OD	3,000	6	MTO	\$21.91	\$7.31
2	x	1.25	10025358	1" ID, 5" OD	1,000	6	Stock	\$7.96	\$7.96

PolyPro 4000D

A direct thermal polypropylene label with an all-temp permanent acrylic adhesive. Offers good resistance to scratching, smearing, and moisture. Provides some flexibility for labeling curved surfaces.

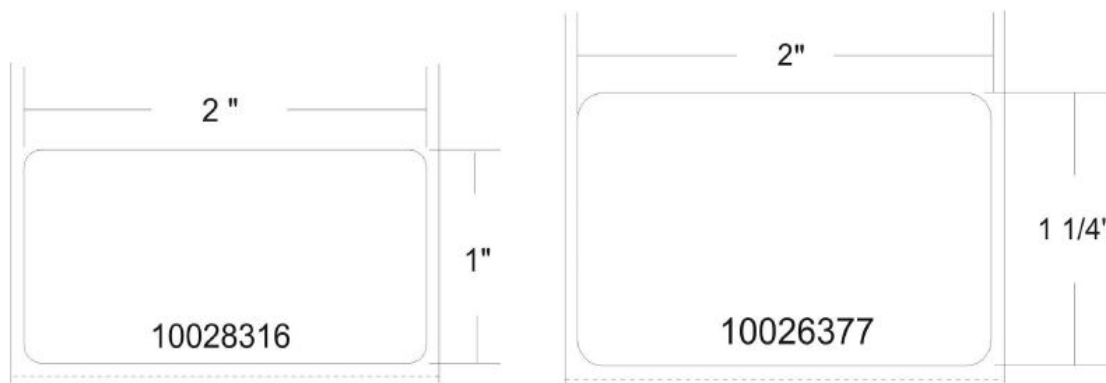

Size			Part #	ID, OD	Amount/ roll	Rolls/ carton	Stock/ MTO	Price/roll	Price/M
W	x	L							
2	x	1	10028316	3" ID, 8" OD	6,000	6	MTO	\$64.41	\$10.74
2	x	1.25	10026377	3" ID, 8" OD	5,000	6	MTO	\$59.04	\$11.81

Stock - ships within one business day. Made to order (MTO) - see product category for specific lead time information.
 Products purchased in less than full inner carton quantities are subject to a \$75 broken carton charge, per destination.
 Prices effective March 9, 2020. Prices/stocking locations subject to change w/o notice. Refer to www.zebra.com.

Lab

Cerner

8000D Lab

A direct thermal paper label with a high-tack permanent acrylic adhesive specifically designed to adhere to small, curved, surfaces.

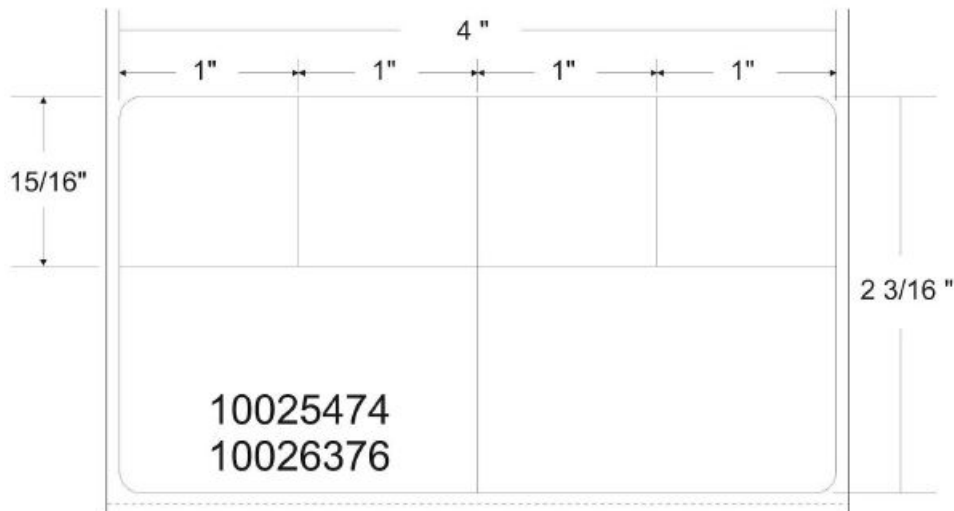

Size			Part #	ID, OD	Amount/ roll	Rolls/ carton	Stock/ MTO	Price/roll	Price/M
W	x	L							
4	x	2.1875	10025474	3" ID, 8" OD	2,600	2	MTO	\$51.10	\$19.66
4	x	2.1875	10026376	1" ID, 5" OD	1,000	2	MTO	\$13.97	\$13.97

PolyPro 4000D

A direct thermal polypropylene label with an all-temp permanent acrylic adhesive. Offers good resistance to scratching, smearing, and moisture. Provides some flexibility for labeling curved surfaces.

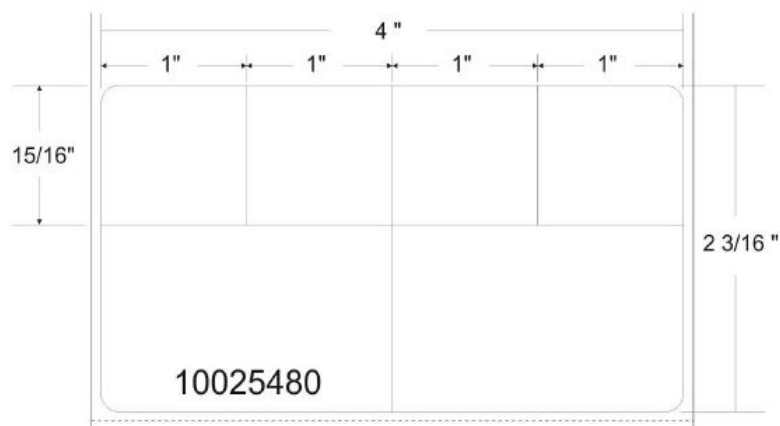

Size			Part #	ID, OD	Amount/ roll	Rolls/ carton	Stock/ MTO	Price/roll	Price/M
W	x	L							
4	x	2.1875	10025480	3" ID, 8" OD	2,600	2	MTO	\$65.63	\$25.25

Stock - ships within one business day. Made to order (MTO) - see product category for specific lead time information.
 Products purchased in less than full inner carton quantities are subject to a \$75 broken carton charge, per destination.
 Prices effective March 9, 2020. Prices/stocking locations subject to change w/o notice. Refer to www.zebra.com.

Lab

Cerner

8000D Lab

A direct thermal paper label with a high-tack permanent acrylic adhesive specifically designed to adhere to small, curved, surfaces.

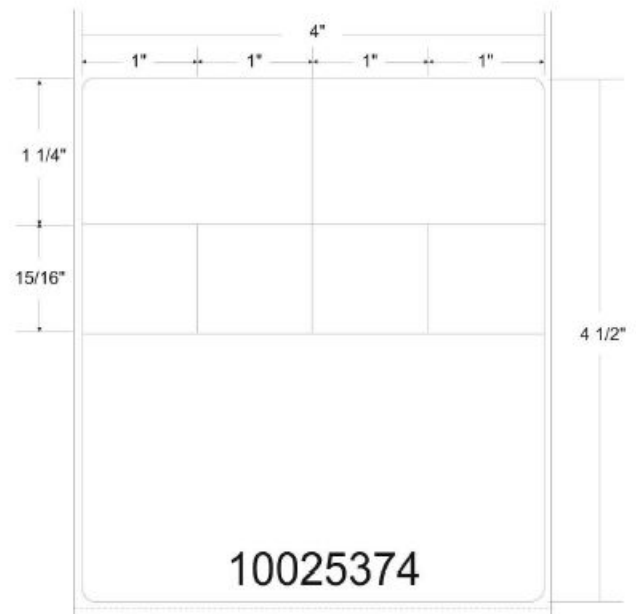
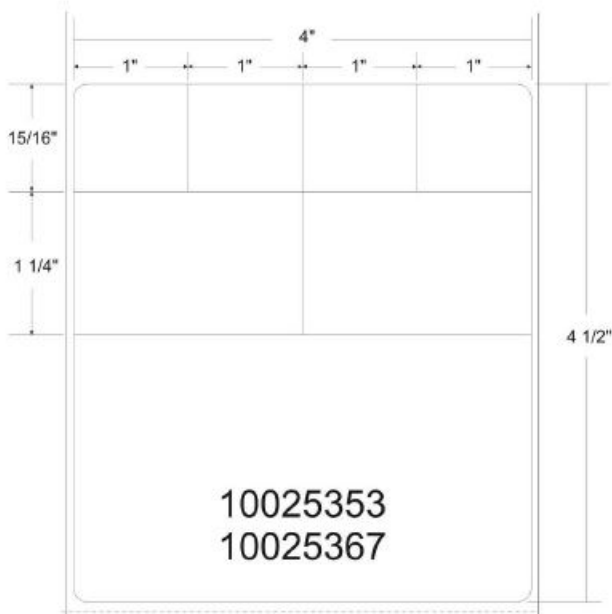

Size			Part #	ID, OD	Amount/ roll	Rolls/ carton	Stock/ MTO	Price/roll	Price/M
W	x	L							
4	x	4.5	10025353	3" ID, 8" OD	1,000	2	MTO	\$32.02	\$32.02
4	x	4.5	10025367	1" ID, 5" OD	500	4	MTO	\$22.42	\$44.84
4	x	4.5	10025374	3" ID, 8" OD	1,000	2	MTO	\$32.02	\$32.02

Stock - ships within one business day. Made to order (MTO) - see product category for specific lead time information.
 Products purchased in less than full inner carton quantities are subject to a \$75 broken carton charge, per destination.
 Prices effective March 9, 2020. Prices/stocking locations subject to change w/o notice. Refer to www.zebra.com.

Lab

Cerner

8000D Lab

A direct thermal paper label with a high-tack permanent acrylic adhesive specifically designed to adhere to small, curved, surfaces.

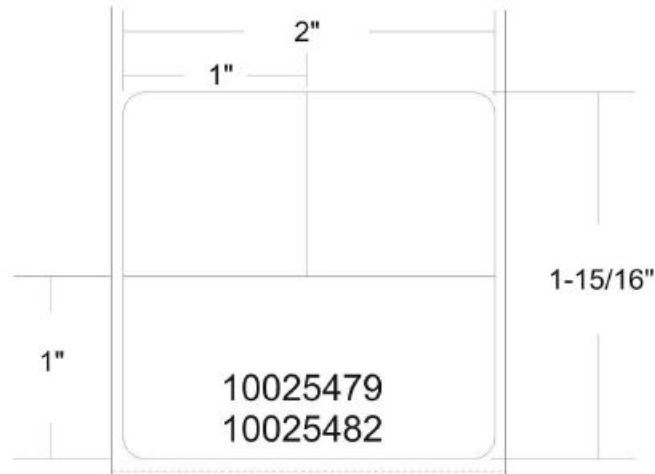

Size			Part #	ID, OD	Amount/ roll	Rolls/ carton	Stock/ MTO	Price/roll	Price/M
W	x	L							
2	x	1.9375	10025479	3" ID, 8" OD	2,700	6	MTO	\$26.12	\$9.68
2	x	1.9375	10025482	1" ID, 5" OD	1,000	6	MTO	\$10.94	\$10.94

8000D Lab

A direct thermal paper label with a high-tack permanent acrylic adhesive specifically designed to adhere to small, curved, surfaces.

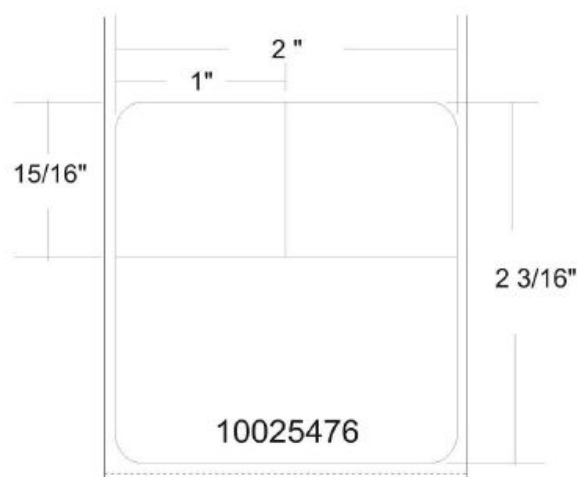

Size			Part #	ID, OD	Amount/ roll	Rolls/ carton	Stock/ MTO	Price/roll	Price/M
W	x	L							
2	x	2.1875	10025476	3" ID, 8" OD	1,000	4	MTO	\$21.12	\$21.12

Stock - ships within one business day. Made to order (MTO) - see product category for specific lead time information.
 Products purchased in less than full inner carton quantities are subject to a \$75 broken carton charge, per destination.
 Prices effective March 9, 2020. Prices/stocking locations subject to change w/o notice. Refer to www.zebra.com.

Lab

Cerner

PolyPro 4000D

A direct thermal polypropylene label with an all-temp permanent acrylic adhesive. Offers good resistance to scratching, smearing, and moisture. Provides some flexibility for labeling curved surfaces.

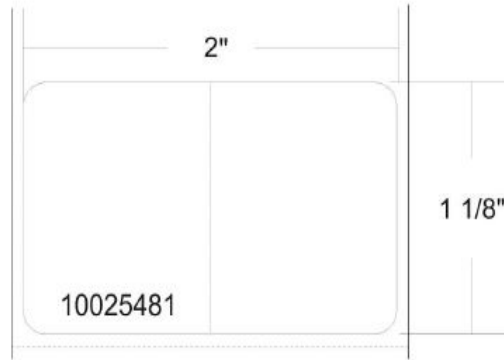

Size			Part #	ID, OD	Amount/ roll	Rolls/ carton	Stock/ MTO	Price/roll	Price/M
W	x	L							
2	x	1.125	10025481	3" ID, 8" OD	5,000	6	MTO	\$43.04	\$8.61

Stock - ships within one business day. Made to order (MTO) - see product category for specific lead time information.
 Products purchased in less than full inner carton quantities are subject to a \$75 broken carton charge, per destination.
 Prices effective March 9, 2020. Prices/stocking locations subject to change w/o notice. Refer to www.zebra.com.

Lab

MISYS/Sunquest

8000D Lab

A direct thermal paper label with a high-tack permanent acrylic adhesive specifically designed to adhere to small, curved, surfaces.

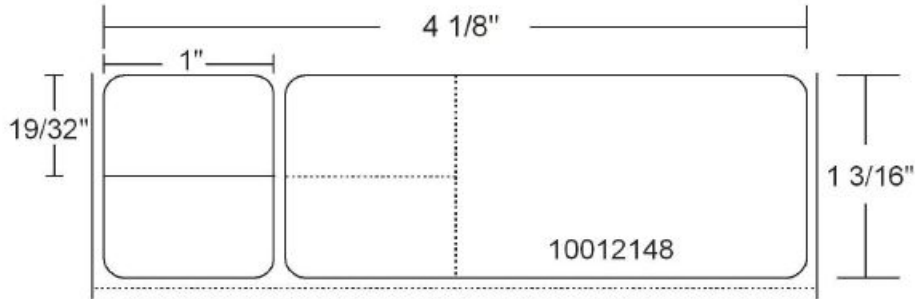

Size			Part #	ID, OD	Color	Amount/ roll	Rolls/ carton	Carton Weight	Stock/ MTO	Price/roll	Price/M
W	x	L									
4.125	x	1.1875	10012148	1" ID, 5" OD	White	2,000	4	20 lbs.	Stock	\$15.58	\$7.79

Meditech

8000D Lab

A direct thermal paper label with a high-tack permanent acrylic adhesive specifically designed to adhere to small, curved, surfaces.

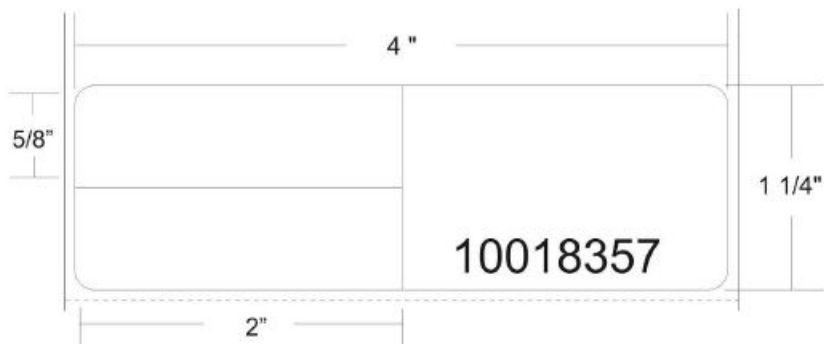

Size			Part #	ID, OD	Color	Amount/ roll	Rolls/ carton	Carton Weight	Stock/ MTO	Price/roll	Price/M
W	x	L									
4	x	1.25	10018357	1" ID, 5" OD	White	1,911	6	26 lbs.	MTO	\$20.56	\$10.76

Stock - ships within one business day. Made to order (MTO) - see product category for specific lead time information.
 Products purchased in less than full inner carton quantities are subject to a \$75 broken carton charge, per destination.
 Prices effective March 9, 2020. Prices/stocking locations subject to change w/o notice. Refer to www.zebra.com.

Lab

Microscope Slide

Z-Xtreme 5000T

A thermal transfer, coated label with a high performance acrylic adhesive that provides extreme chemical resistance.

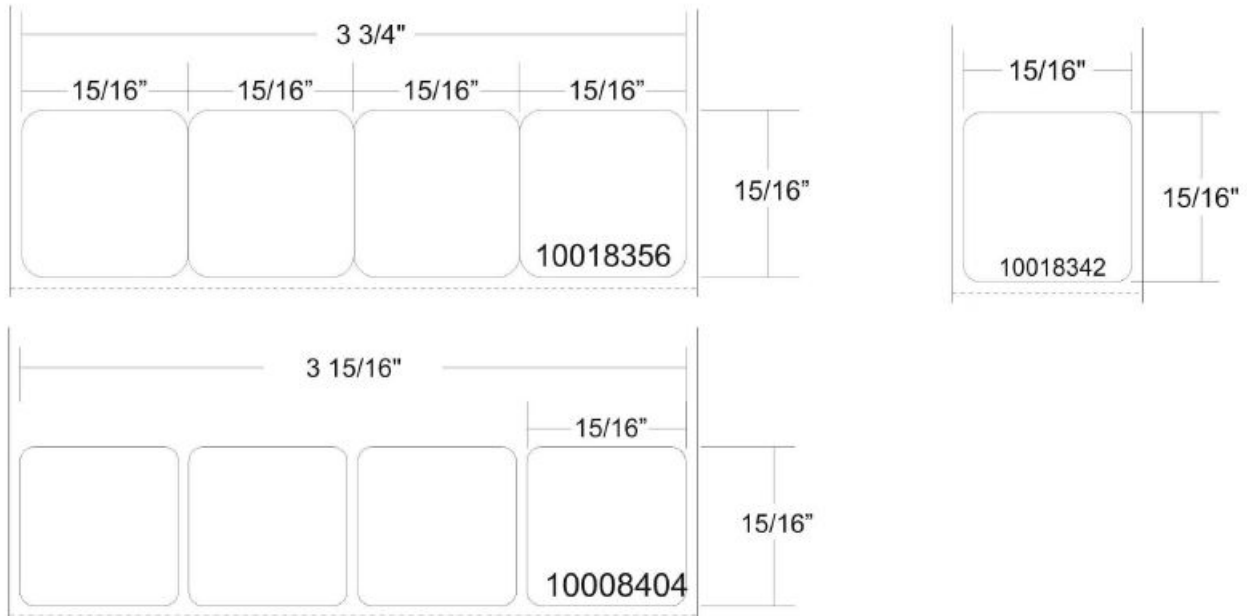

Size			Part #	ID, OD	Amount/ roll	Rolls/ carton	Carton Weight	Stock/ MTO	Price/roll	Price/M	Ribbon Part Number*
W	x	L									
0.9375	x	0.9375	10018356	1" ID, 5" OD	8,780	4	6 lbs.	MTO	\$109.98	\$50.11	74943, 74783 [^]
0.9375	x	0.9375	10008404	1" ID, 5" OD	8,760	4	6 lbs.	Stock	\$105.75	\$48.29	74943, 74783 [^]
0.9375	x	0.9375	10018342	1" ID, 5" OD	2,195	4	4 lbs.	Stock	\$109.18	\$49.75	74941

*Ribbon pricing located on the last page of the price list
[^]74783 for the ZD420 printer only

Lab

Microscope Slide

8000T Slide

Thermal transfer, premium, white gloss polyester label with a permanent acrylic adhesive. Withstands immersion in harsh chemicals when paired with Image Lock ribbon.

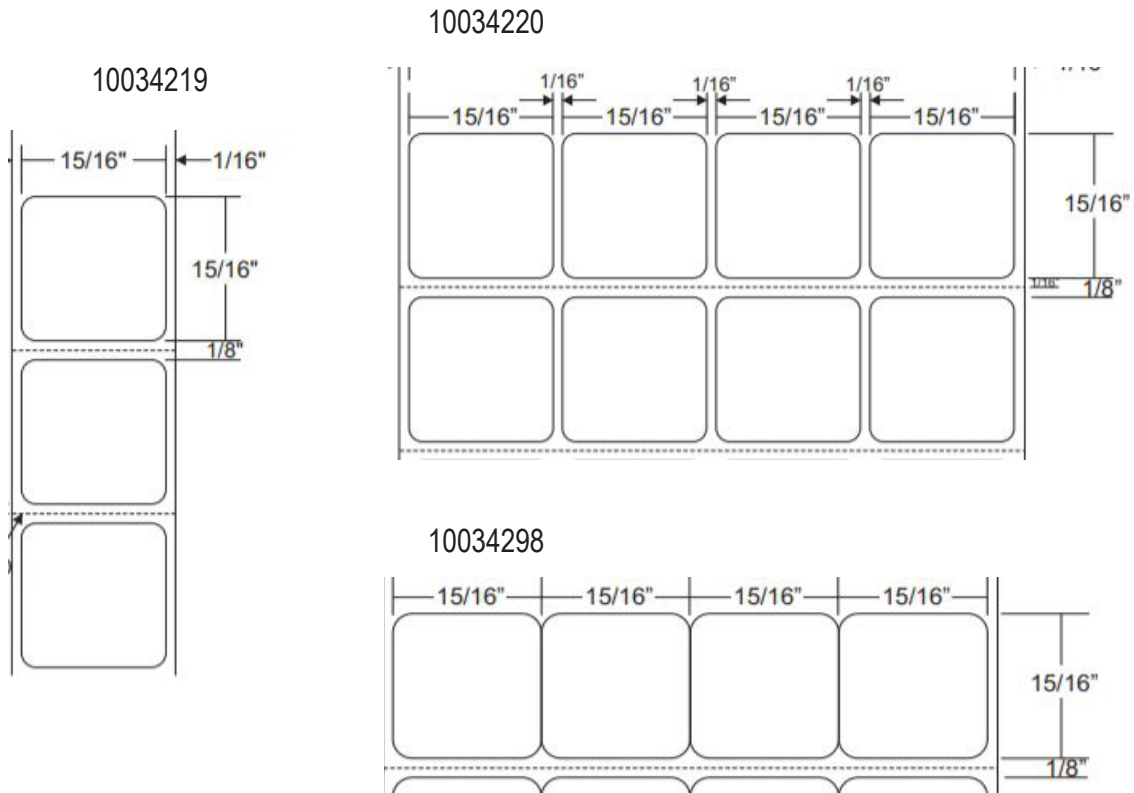

Size			Part #	ID, OD	Lables/ across	Amount/ roll	Rolls/ carton	Carton Weight	Stock/ MTO	Price/roll	Price/M
W	x	L									
0.9375	x	0.9375	10034219	1" ID, 5" OD	1	2,512	4	4 lbs.	Stock	\$114.00	\$45.38
0.9375	x	0.9375	10034220	1" ID, 5" OD	4	10,048	4	8 lbs.	Stock	\$149.99	\$14.93

Size			Part #	ID, OD	Lables/ across	Amount/ roll	Rolls/ carton	Carton Weight	Stock/ MTO	Price/roll	Price/M
W	x	L									
0.9375	x	0.9375	10034298	1" ID, 5" OD	4	8,760	4	8 lbs.	Stock	\$114.00	\$13.01

No gap between labels across.

Stock - ships within one business day. Made to order (MTO) - see product category for specific lead time information.
 Products purchased in less than full inner carton quantities are subject to a \$75 broken carton charge, per destination.
 Prices effective March 9, 2020. Prices/stocking locations subject to change w/o notice. Refer to www.zebra.com.

Lab

General

8000D Lab

A direct thermal paper label with a high-tack permanent acrylic adhesive specifically designed to adhere to small, curved, surfaces.

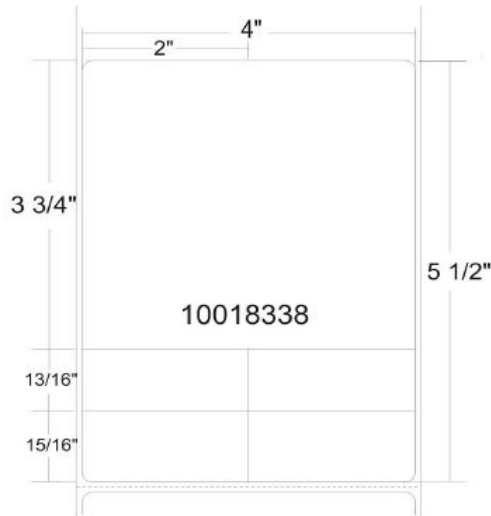

Size			Part #	ID, OD	Amount/ roll	Rolls/ carton	Carton Weight	Stock/ MTO	Price/roll	Price/M
W	x	L								
4	x	5.5	10018338	3" ID, 8" OD	1,050	4	26 lbs.	Stock	\$25.39	\$24.19

PolyPro 4000D

A direct thermal polypropylene label with an all-temp permanent acrylic adhesive. Offers good resistance to scratching, smearing, and moisture. Provides some flexibility for labeling curved surfaces.

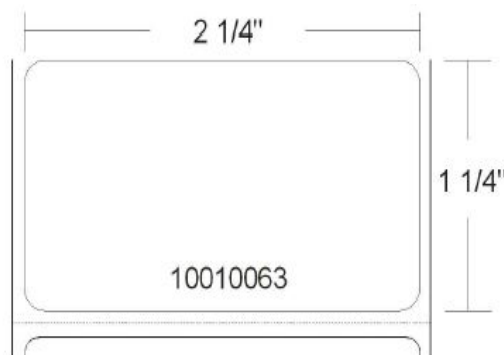

Size			Part #	ID, OD	Amount/ roll	Rolls/ carton	Carton Weight	Stock/ MTO	Price/roll	Price/M
W	x	L								
2.25	x	1.25	10010063	1" ID, 5" OD	2,000	6	12 lbs.	Stock	\$26.05	\$13.03

Stock - ships within one business day. Made to order (MTO) - see product category for specific lead time information.
 Products purchased in less than full inner carton quantities are subject to a \$75 broken carton charge, per destination.
 Prices effective March 9, 2020. Prices/stocking locations subject to change w/o notice. Refer to www.zebra.com.

Lab

General

PolyPro 4000T

A thermal transfer Kimdura® polypropylene label with a permanent acrylic adhesive.

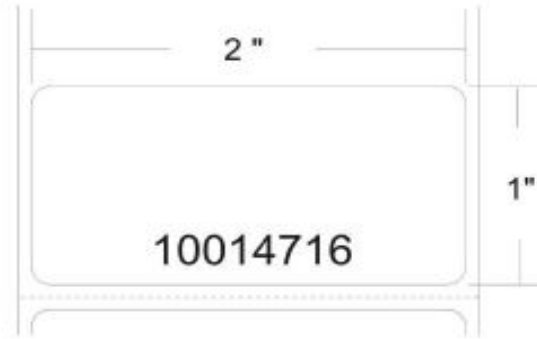

Size			Part #	ID, OD	Amount/ roll	Rolls/ carton	Carton Weight	Stock/ MTO	Price/roll	Price/M	Ribbon Part Number*
W	x	L									
2	x	1	10014716	3" ID, 8" OD	3,940	4	10 lbs.	Stock	\$46.77	\$11.88	06100BK06045

*Ribbon pricing located on the last page of the price list.

ISBT 128

General

8000T Primary Blood Bag Label

A thermal transfer polypropylene label with a permanent acrylic adhesive for direct application to a blood bag.

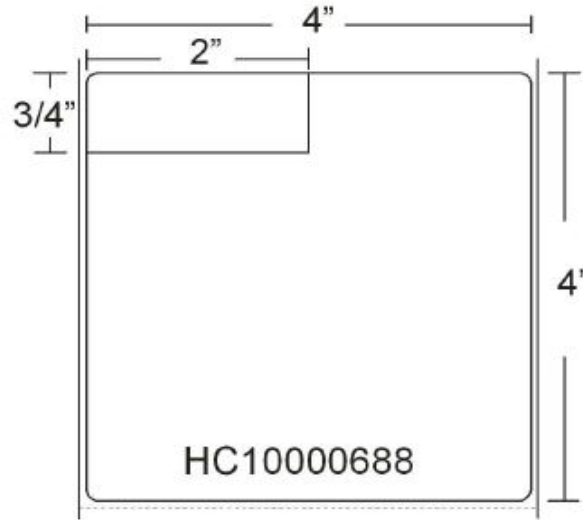

Size			Part #	ID, OD	Amount/ roll	Rolls/ carton	Carton Weight	Stock/ MTO	Price/roll	Price/M	Ribbon Part Number*
W	x	L									
4	x	4	HC10000688	3" ID, 8" OD	1,110	4	24 lbs.	Stock	\$72.16	\$65.01	06100BK11045

*Ribbon pricing located on the last page of the price list.

Mobile Specimen Collection

Cerner, McKesson, Siemens

8000D Lab

A direct thermal paper label with a permanent acrylic adhesive specifically designed to adhere to small, curved surfaces.

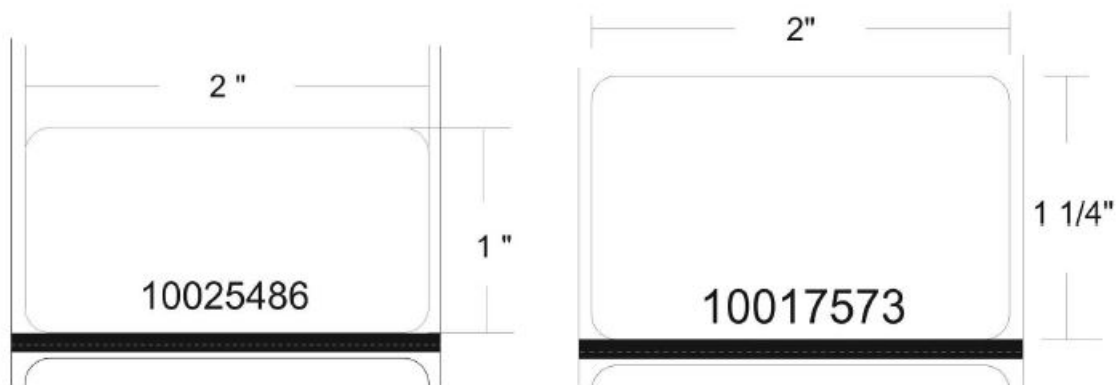

Size			Part #	ID, OD	Amount/ roll	Rolls/ carton	Carton Weight	Stock/ MTO	Price/roll	Price/M
W	x	L								
2	x	1	10025486	0.75" ID, 2.2" OD	428	12	3 lbs.	MTO	\$8.36	\$19.54
2	x	1.25	10017573	0.75" ID, 2.2" OD	330	12	3 lbs.	Stock	\$8.95	\$27.13

PolyPro 4000D

A direct thermal polypropylene label with an all-temp permanent acrylic adhesive. Offers good resistance to scratching, smearing and moisture. Provides some flexibility for labeling curved surfaces.

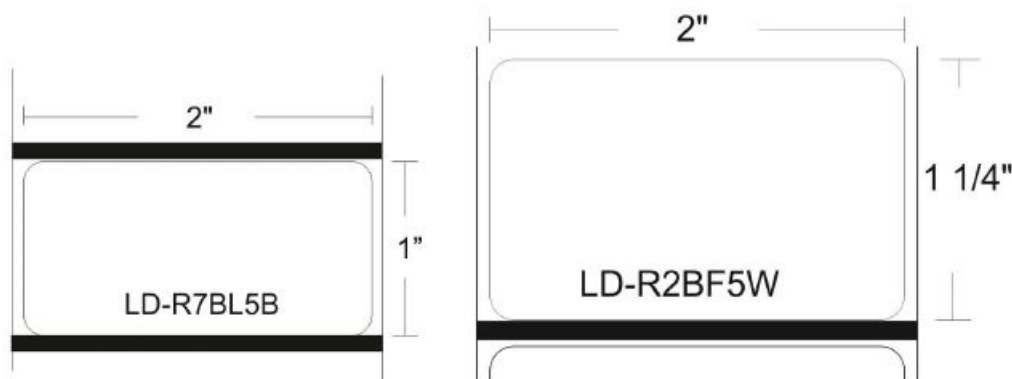

Size			Part #	ID, OD	Amount/ roll	Rolls/ carton	Carton Weight	Stock/ MTO	Price/roll	Price/M
W	x	L								
2	x	1	LD-R7BL5B	0.75" ID, 2" OD	350	36	7 lbs.	Stock	\$4.52	\$12.92
2	x	1.25	LD-R2BF5W	0.75" ID, 2" OD	280	36	8 lbs.	Stock	\$4.95	\$17.68

Stock - ships within one business day. Made to order (MTO) - see product category for specific lead time information. Products purchased in less than full inner carton quantities are subject to a \$75 broken carton charge, per destination. Prices effective March 9, 2020. Prices/stocking locations subject to change w/o notice. Refer to www.zebra.com.

Mobile Specimen Collection

Cerner

8000D Lab

A direct thermal paper label with a permanent acrylic adhesive specifically designed to adhere to small, curved surfaces.

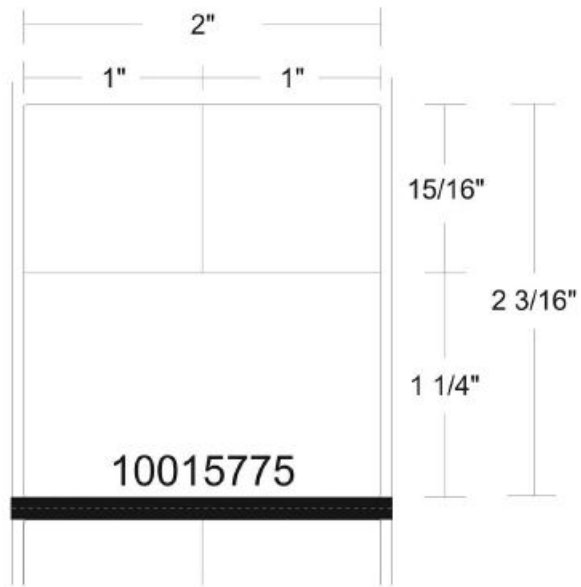
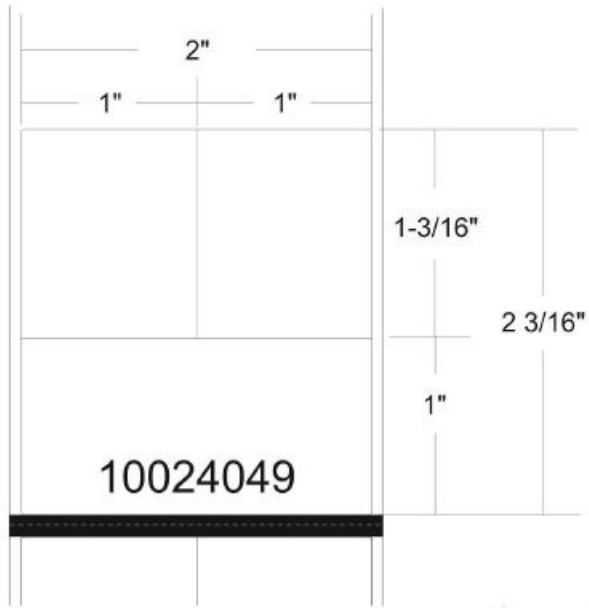

Size			Part #	ID, OD	Amount/ roll	Rolls/ carton	Carton Weight	Stock/ MTO	Price/roll	Price/M
W	x	L								
2	x	2.1875	10015775	0.75" ID, 2.2" OD	200	12	5 lbs.	Stock	\$9.24	\$46.20
2	x	2.1875	10024049	0.75" ID, 2.2" OD	200	36	15 lbs.	Stock	\$9.24	\$46.20

Stock - ships within one business day. Made to order (MTO) - see product category for specific lead time information.
 Products purchased in less than full inner carton quantities are subject to a \$75 broken carton charge, per destination.
 Prices effective March 9, 2020. Prices/stocking locations subject to change w/o notice. Refer to www.zebra.com.

Mobile Specimen Collection

Meditech

8000D Lab

A direct thermal paper label with a permanent acrylic adhesive specifically designed to adhere to small, curved surfaces.

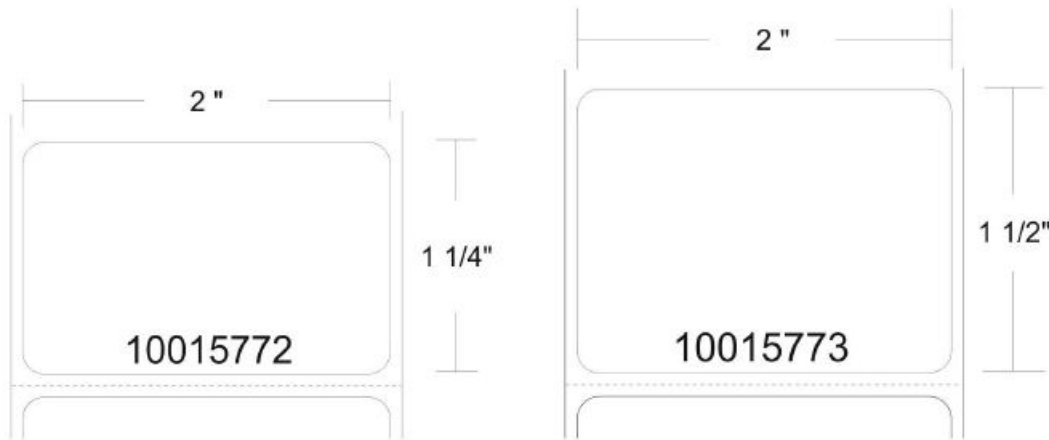

Size			Part #	ID, OD	Amount/ roll	Rolls/ carton	Carton Weight	Stock/ MTO	Price/roll	Price/M
W	x	L								
2	x	1.25	10015772	0.75" ID, 2.2" OD	330	12	3 lbs.	Stock	\$8.36	\$25.34
2	x	1.5	10015773	0.75" ID, 2.2" OD	280	12	3 lbs.	Stock	\$8.36	\$29.86

PolyPro 4000D

A direct thermal polypropylene label with an all-temp permanent acrylic adhesive. Offers good resistance to scratching, smearing and moisture. Provides some flexibility for labeling curved surfaces.

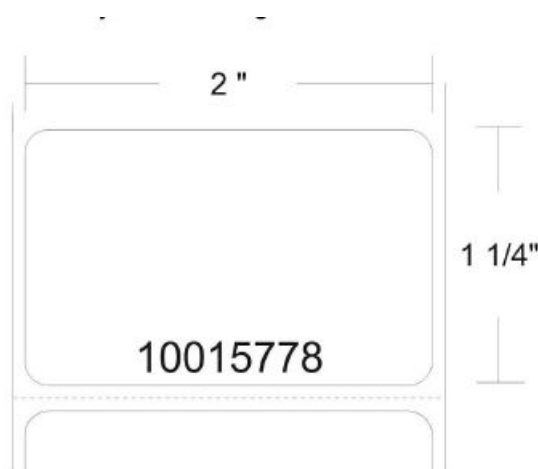

Size			Part #	ID, OD	Amount/ roll	Rolls/ carton	Carton Weight	Stock/ MTO	Price/roll	Price/M
W	x	L								
2	x	1.25	10015778	0.75" ID, 2.2" OD	380	12	3 lbs.	Stock	\$13.85	\$36.45

Stock - ships within one business day. Made to order (MTO) - see product category for specific lead time information.
 Products purchased in less than full inner carton quantities are subject to a \$75 broken carton charge, per destination.
 Prices effective March 9, 2020. Prices/stocking locations subject to change w/o notice. Refer to www.zebra.com.

Mobile Specimen Collection

Meditech

8000D Lab

A direct thermal paper label with a permanent acrylic adhesive specifically designed to adhere to small, curved surfaces.

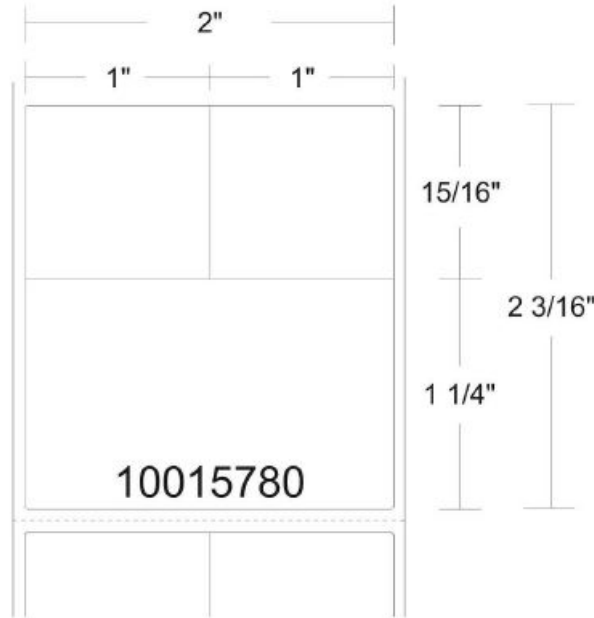

Size			Part #	ID, OD	Amount/ roll	Rolls/ carton	Carton Weight	Stock/ MTO	Price/roll	Price/M
W	x	L								
2	x	2.1875	10015780	0.75" ID, 2.2" OD	200	12	3 lbs.	Stock	\$9.01	\$45.05

Stock - ships within one business day. Made to order (MTO) - see product category for specific lead time information.
 Products purchased in less than full inner carton quantities are subject to a \$75 broken carton charge, per destination.
 Prices effective March 9, 2020. Prices/stocking locations subject to change w/o notice. Refer to www.zebra.com.

Mobile Specimen Collection

IQ Color Specimen Collection Labels

IQ Color 2000D

A white, coated direct thermal paper label with a permanent acrylic adhesive which allows the ability to print vibrant color on-demand in pre-defined zones to be used as a visual cue.



Size			Part #	ID, OD	Amount/ roll	Rolls/ carton	Carton Weight	Stock/ MTO	Price/roll	Price/M
W	x	L								
2	x	1	10020397	0.75" ID, 2.2" OD	450	36	18 lbs.	Stock	\$8.95	\$19.89

Red color zone runs along left edge of the label and measures 0.25" wide x 1" long.
Black mark sensing and perforation between labels.

Pharmacy

Cerner

Z-Perform 2000D

A direct thermal paper label with a permanent acrylic adhesive.

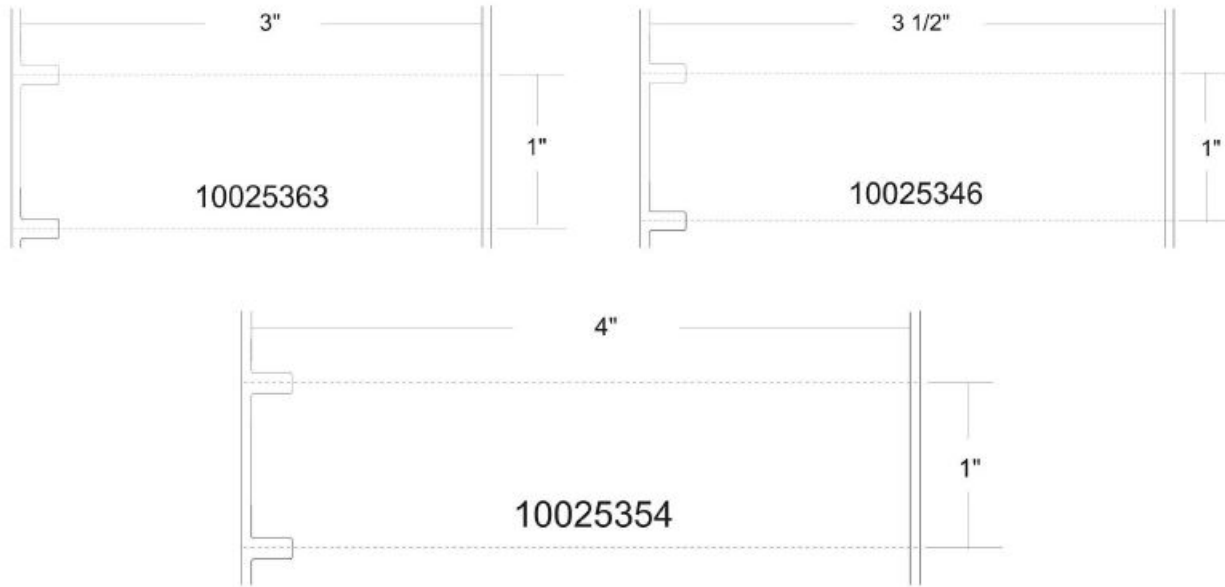

Size			Part #	ID, OD	Amount/ roll	Rolls/ carton	Stock/ MTO	Price/roll	Price/M
W	x	L							
3	x	1	10025363	3" ID, 8" OD	5,000	2	MTO	\$38.57	\$7.72
3.5	x	1	10025346	3" ID, 8" OD	5,800	2	MTO	\$32.59	\$5.62
4	x	1	10025354	3" ID, 8" OD	6,000	2	MTO	\$51.78	\$8.63

Stock - ships within one business day. Made to order (MTO) - see product category for specific lead time information.
 Products purchased in less than full inner carton quantities are subject to a \$75 broken carton charge, per destination.
 Prices effective March 9, 2020. Prices/stocking locations subject to change w/o notice. Refer to www.zebra.com.

Pharmacy

General

Z-Select 4000D

A direct thermal, bright white coated paper label with an all-temp permanent acrylic adhesive.

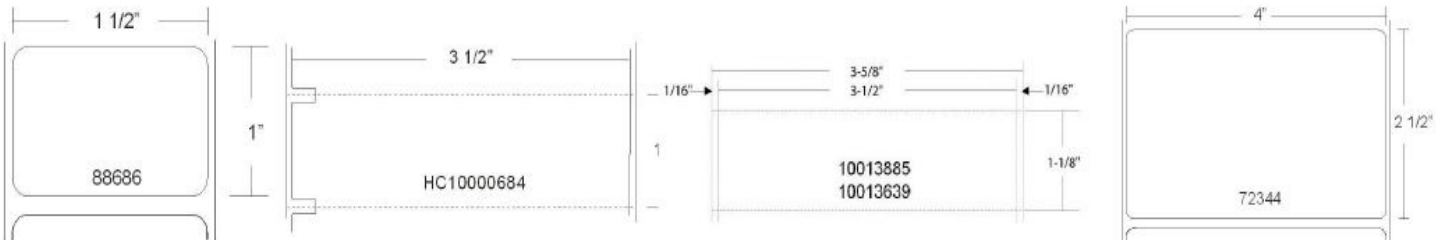

Size			Part #	ID, OD	Amount/ roll	Rolls/ carton	Carton Weight	Stock/ MTO	Price/roll	Price/M
W	x	L								
1.5	x	1	88686	3" ID, 8" OD	5,120	14	29 lbs.	Stock	\$26.17	\$5.12
3.5	x	1	HC10000684	3" ID, 8" OD	5,760	6	30 lbs.	Stock	\$41.24	\$7.16
3.5	x	1.125	10013885	1" ID, 5" OD	2,374	4	10 lbs.	MTO	\$42.90	\$18.08
4	x	2.5	72344	3" ID, 8" OD	2,220	4	25 lbs.	Stock	\$57.96	\$26.11

Z-Select 4000T

A premium, thermal transfer, bright white, coated, ultra-smooth paper label with a permanent acrylic adhesive.

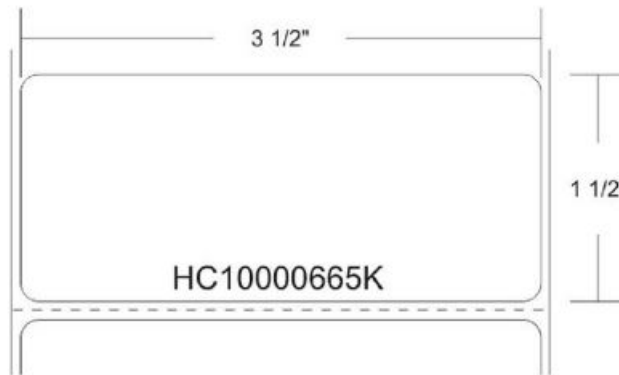

Size			Part #	ID, OD	Amount/ roll	Rolls/ carton	Carton Weight	Stock/MTO	Price/kit
W	x	L							
3.5	x	1.5	HC10000665K	1" ID, 5" OD	1,570	3	15 lbs.	Stock	\$43.37

*Kit includes 3 rolls of labels and 3 rolls of ribbon part number 05319GS11007. Perforation between labels.

Breast Milk Tracking

Cerner, McKesson, Siemens

PolyPro 4000D

A direct thermal polypropylene label with an all-temp permanent acrylic adhesive. For use in water temperatures up to 160°F.

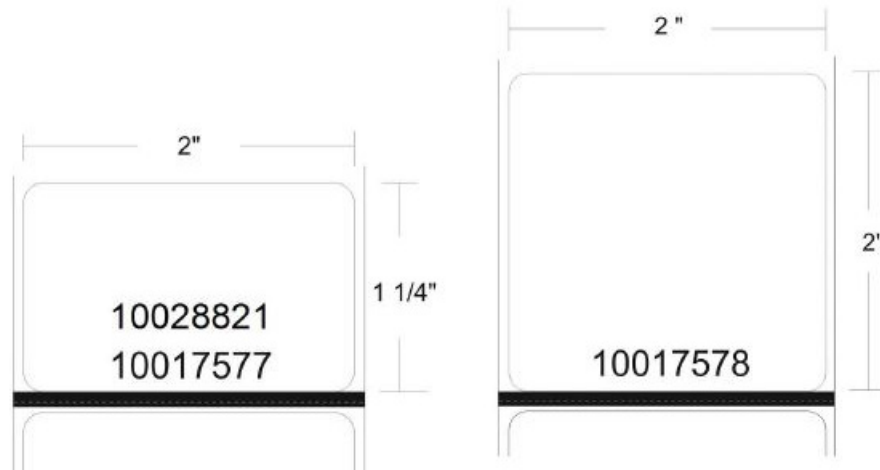

Size			Part #	ID, OD	Amount/ roll	Rolls/ carton	Carton Weight	Stock/ MTO	Price/roll	Price/M
W	x	L								
2	x	1.25	10028821	1" ID, 5" OD	2,189	8	14 lbs.	MTO	\$19.42	\$8.88
2	x	1.25	10017577	0.75" ID, 2.2" OD	380	12	3 lbs.	Stock	\$16.16	\$42.53
2	x	2	10017578	0.75" ID, 2.2" OD	245	12	3 lbs.	Stock	\$16.16	\$65.96

Labels equipped with overprotective varnish.

Breast Milk Tracking

CareFusion

Z-Ultimate 4000T

A thermal transfer, pearl white, gloss polyester label with a high performance acrylic adhesive. Provides unparalleled smear and scratch resistance to moderate chemicals.

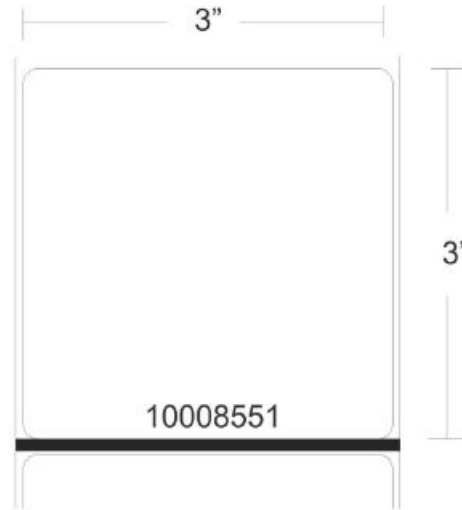

Size			Part #	ID, OD	Amount/ roll	Rolls/ carton	Carton Weight	Stock/ MTO	Price/roll	Price/M	Ribbon Part Number*
W	x	L									
3	x	3	10008551	0.75" ID, 2.6" OD	230	12	16 lbs.	Stock	\$35.70	\$155.22	05095BK110D

*Ribbon pricing located on the last page of the price list.

Multipurpose

General

Z-Perform 2000D

A white, coated direct thermal paper label with an all-temp permanent acrylic adhesive.

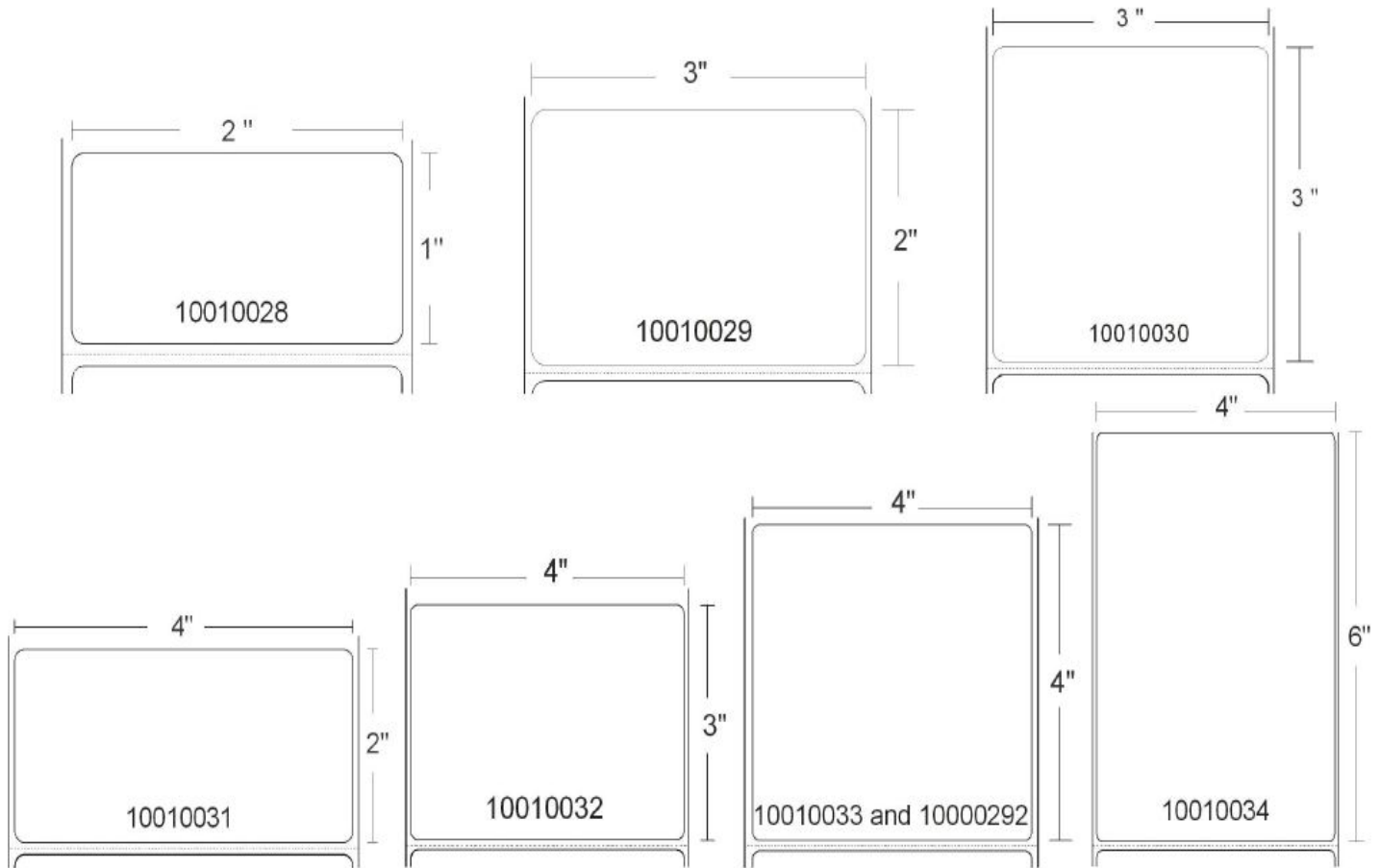

Size			Part #	ID, OD	Amount/ roll	Rolls/ carton	Carton Weight	Stock/ MTO	Price/roll	Price/M
W	x	L								
2	x	1	10010028	1" ID, 5" OD	2,340	6	10 lbs.	Stock	\$12.22	\$5.23
3	x	2	10010029	1" ID, 5" OD	1,240	6	11 lbs.	Stock	\$14.94	\$12.05
4	x	2	10010031	1" ID, 5" OD	1,240	6	14 lbs.	Stock	\$19.85	\$16.01
4	x	3	10010032	1" ID, 5" OD	840	6	15 lbs.	Stock	\$14.95	\$17.80
4	x	4	10000292	3" ID, 8" OD	1,500	4	26 lbs.	Stock	\$31.18	\$20.79
4	x	4	10010033	1" ID, 5" OD	640	6	15 lbs.	Stock	\$17.71	\$27.68
4	x	6	10010034	1" ID, 5" OD	430	6	16 lbs.	Stock	\$13.64	\$31.73

Stock - ships within one business day. Made to order (MTO) - see product category for specific lead time information.
 Products purchased in less than full inner carton quantities are subject to a \$75 broken carton charge, per destination.
 Prices effective March 9, 2020. Prices/stocking locations subject to change w/o notice. Refer to www.zebra.com.

Multipurpose

General

Z-Perform 2000D Floodcoated

A coated direct thermal paper label with an all-temp permanent acrylic adhesive.

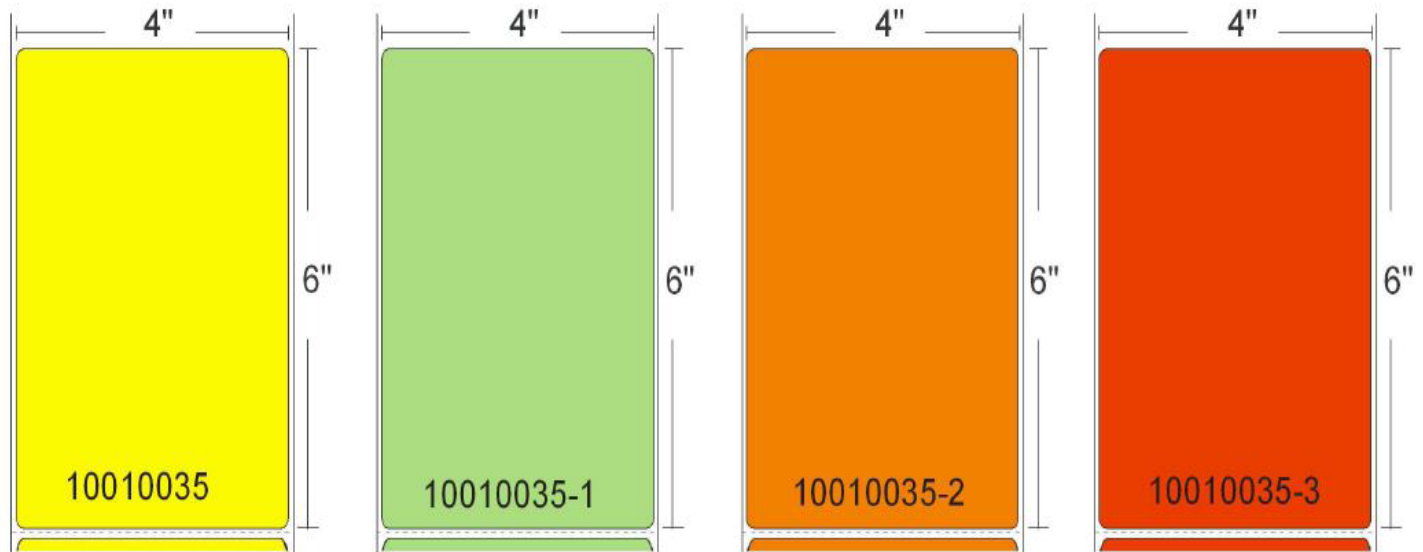

Size			Part #	ID, OD	Color	Amount/ roll	Rolls/ carton	Carton Weight	Stock/ MTO	Price/roll	Price/M
W	x	L									
4	x	6	10010035	1" ID, 5" OD	Yel.	430	6	16 lbs.	Stock	\$21.07	\$49.00
4	x	6	10010035-1	1" ID, 5" OD	Grn.	430	6	12 lbs.	Stock	\$21.07	\$49.00
4	x	6	10010035-2	1" ID, 5" OD	Org.	430	6	12 lbs.	Stock	\$21.07	\$49.00
4	x	6	10010035-3	1" ID, 5" OD	Red	430	6	12 lbs.	Stock	\$21.07	\$49.00

Stock - ships within one business day. Made to order (MTO) - see product category for specific lead time information.
 Products purchased in less than full inner carton quantities are subject to a \$75 broken carton charge, per destination.
 Prices effective March 9, 2020. Prices/stocking locations subject to change w/o notice. Refer to www.zebra.com.

Multipurpose

General

Z-Select 4000D

A direct thermal, bright white coated paper label with an all-temp permanent acrylic adhesive.

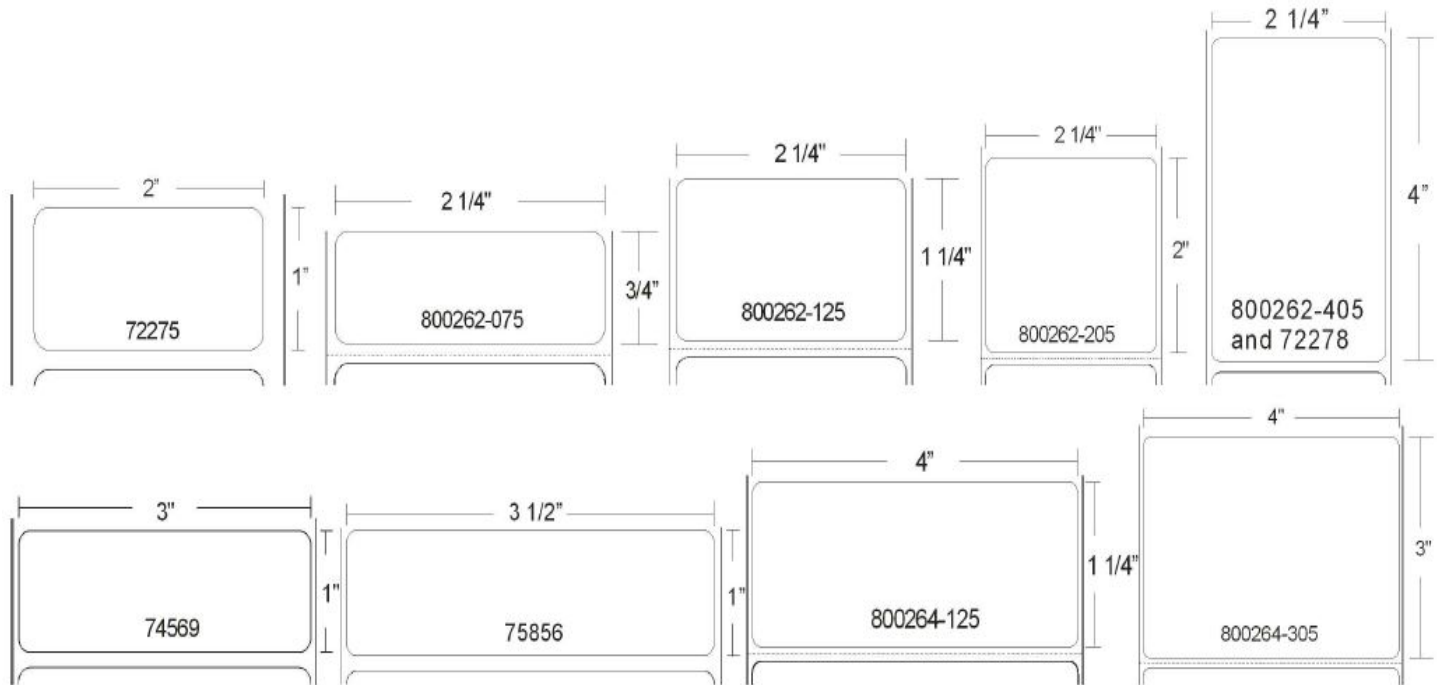

Size			Part #	ID, OD	Amount/ roll	Rolls/ carton	Carton Weight	Stock/ MTO	Price/roll	Price/M
W	x	L								
2	x	1	72275	3" ID, 8" OD	4,620	8	22 lbs.	Stock	\$28.70	\$6.22
2.25	x	0.75	10015340	1" ID, 5" OD	3,315	12	20 lbs.	Stock	\$14.36	\$4.34
2.25	x	1.25	10015341	1" ID, 5" OD	2,100	12	20 lbs.	Stock	\$14.22	\$6.78
2.25	x	2	10015342	1" ID, 5" OD	1,370	12	20 lbs.	Stock	\$14.35	\$10.48
2.25	x	4	10015343	1" ID, 5" OD	700	12	20 lbs.	Stock	\$14.16	\$20.23
2.25	x	4	72278	3" ID, 8" OD	1,260	8	25 lbs.	Stock	\$28.77	\$22.84
3	x	1	74569	3" ID, 8" OD	5,120	6	24 lbs.	Stock	\$49.62	\$9.70
3.5	x	1	75856	3" ID, 8" OD	5,120	6	29 lbs.	Stock	\$48.67	\$9.51
4	x	1.25	10015349	1" ID, 5" OD	2,100	12	28 lbs.	Stock	\$27.48	\$13.09
4	x	3	10015344	1" ID, 5" OD	930	12	30 lbs.	Stock	\$23.53	\$25.31

Stock - ships within one business day. Made to order (MTO) - see product category for specific lead time information.
 Products purchased in less than full inner carton quantities are subject to a \$75 broken carton charge, per destination.
 Prices effective March 9, 2020. Prices/stocking locations subject to change w/o notice. Refer to www.zebra.com.

Specialty

Radiology

Z-Select 4000D Specialty

A direct thermal, bright white coated paper label with an all-temp permanent acrylic adhesive.

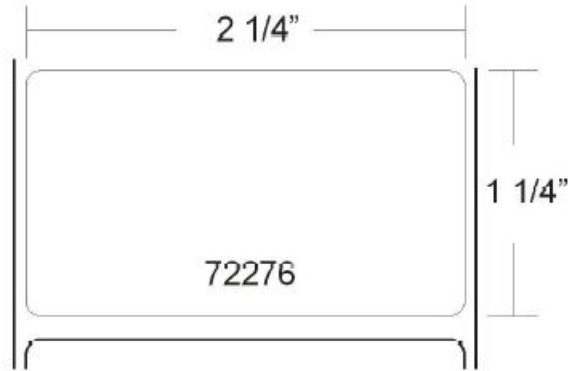

Size			Part #	ID, OD	Amount/ roll	Rolls/ carton	Carton Weight	Stock/ MTO	Price/roll	Price/M
W	x	L								
2.25	x	1.25	72276	3" ID, 8" OD	3,770	8	24 lbs.	Stock	\$28.64	\$7.60

Stock - ships within one business day. Made to order (MTO) - see product category for specific lead time information.
 Products purchased in less than full inner carton quantities are subject to a \$75 broken carton charge, per destination.
 Prices effective March 9, 2020. Prices/stocking locations subject to change w/o notice. Refer to www.zebra.com.

Specialty

Sterilization

Z-Ultimate 2000T White

A pearl white, gloss polyester thermal transfer label with a high performance permanent acrylic adhesive.

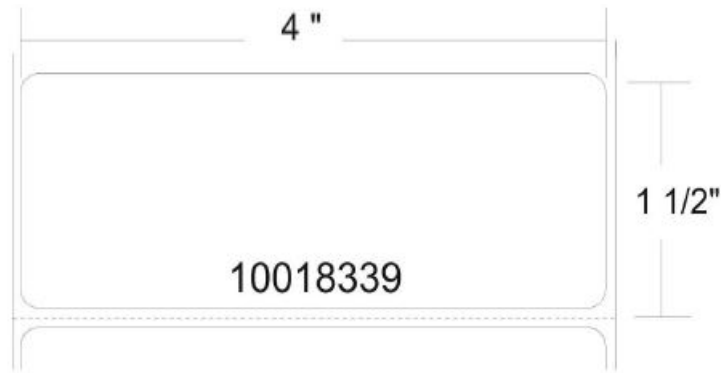

Size			Part #	ID, OD	Amount/ roll	Rolls/ carton	Carton Weight	Stock/ MTO	Price/roll	Price/M	Ribbon Part Number*
W	x	L									
4	x	1.5	10018339	3" ID, 8" OD	3,800	4	32 lbs	Stock	\$124.58	\$32.79	06200BK11045

*Ribbon pricing located on the last page of the price list.

Z-Ultimate 3000T White

A pearl white, gloss polyester thermal transfer label with a high performance permanent acrylic adhesive

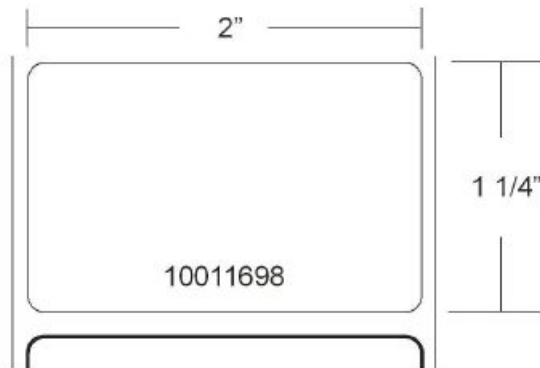

Size			Part #	ID, OD	Amount/ roll	Rolls/ carton	Carton Weight	Stock/ MTO	Price/roll	Price/M	Ribbon Part Number*
W	x	L									
2	x	1.25	10011698	3" ID, 8" OD	4,270	4	10 lbs.	Stock	\$98.04	\$22.97	06200BK06045

*Ribbon pricing located on the last page of the price list

Specialty

Asset Tracking

PolyPro 4000T

A thermal transfer Kimdura® polypropylene label with a permanent acrylic adhesive.

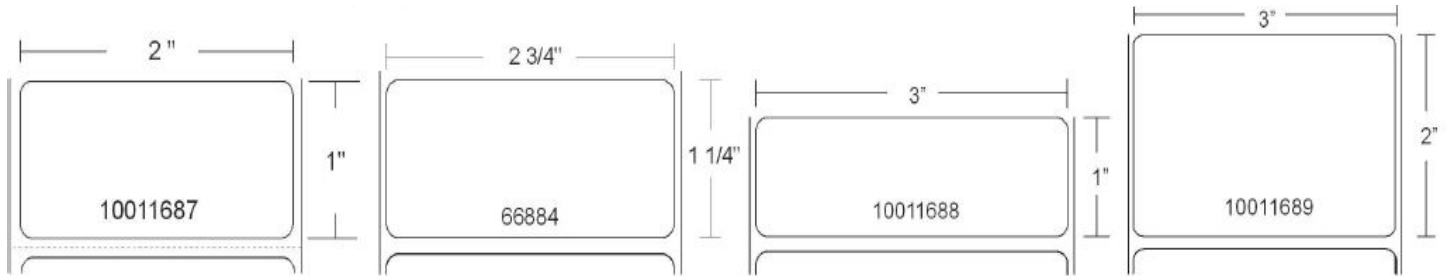

Size			Part #	ID, OD	Amount/ roll	Rolls/ carton	Carton Weight	Stock/ MTO	Price/roll	Price/M	Ribbon Part Number*
W	x	L									
2	x	1	10014716	3" ID, 8" OD	3,940	4	10 lbs.	Stock	\$46.77	\$11.88	06100BK06045
2.75	x	1.25	10014717	3" ID, 8" OD	3,210	4	28 lbs.	Stock	\$60.77	\$18.94	06100BK08045
3	x	1	10011688	3" ID, 8" OD	4,350	4	20 lbs.	Stock	\$72.91	\$16.77	06100BK08045
3	x	2	10011689	3" ID, 8" OD	2,230	4	20 lbs.	Stock	\$72.91	\$32.70	06100BK08045

*Ribbon pricing located on the last page of the price list

Wristbands

Wristband Cartridges

Z-Band UltraSoft Kit

Ultra-soft and flexible direct thermal polypropylene and vinyl wristband with an adhesive tamper-evident tab for securement. Scannable up to 14 days. Wristbands contained in an easy-to-load cartridge for the HC100/ZD510 Printer.

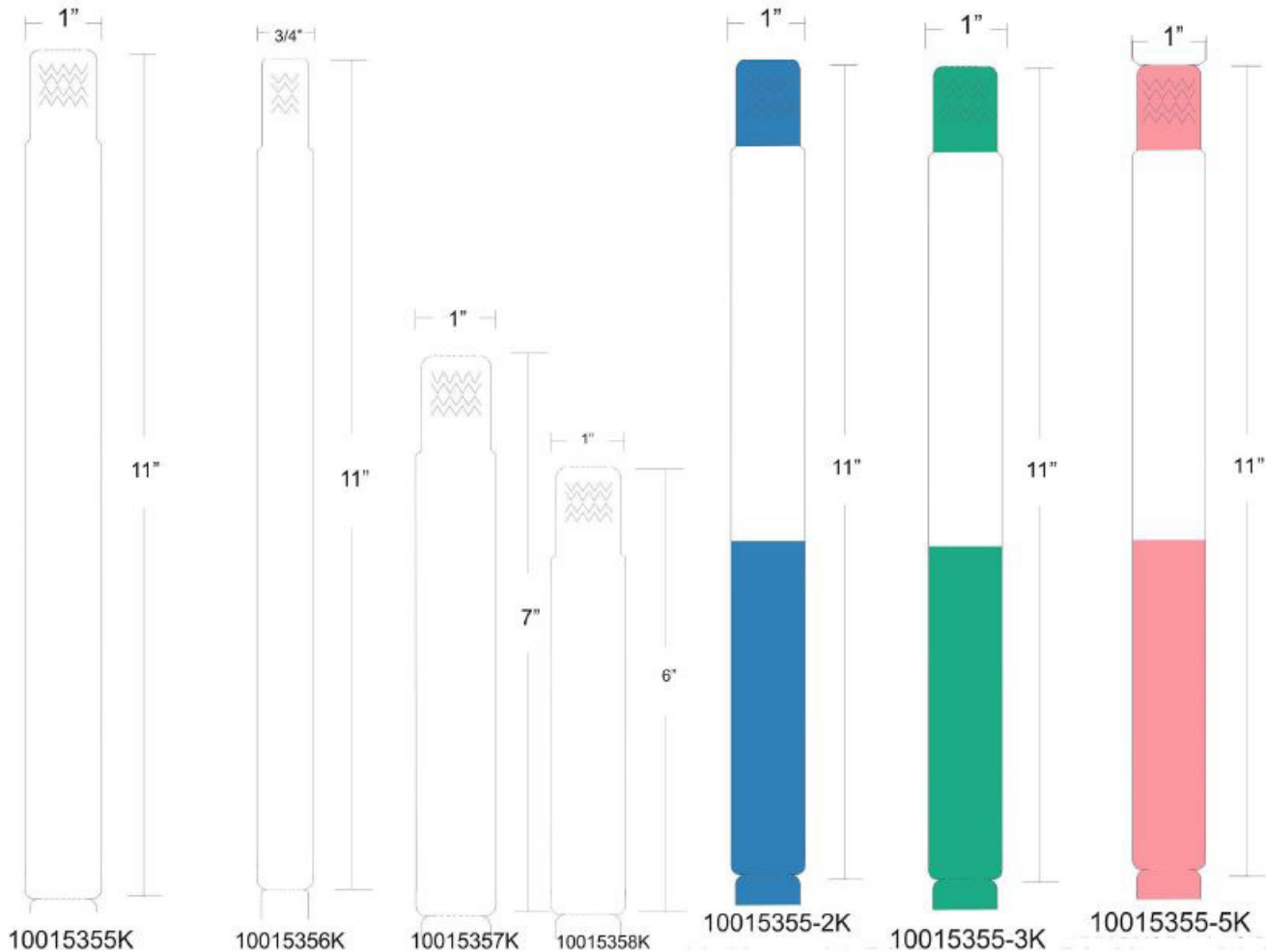

Size			Part #	Color	Amount/roll	Rolls/carton	Carton Weight	Stock/ MTO	Price/kit
W	x	L							
1	x	11	10015355-2K	Blue	175	6	6 lbs.	Stock	\$316.79
1	x	11	10015355-3K	Green	175	6	6 lbs.	Stock	\$316.79
1	x	11	10015355-5K	Pink	175	6	6 lbs.	Stock	\$316.79
1	x	11	10015355K	White	175	6	6 lbs.	Stock	\$288.29
0.75	x	11	10015356K	White	175	6	6 lbs.	Stock	\$288.29
1	x	7	10015357K	White	250	6	6 lbs.	Stock	\$364.31
1	x	6	10015358K	White	300	6	6 lbs.	Stock	\$427.68

Must be ordered in carton quantities. Each part number represents 1 carton.

Stock - ships within one business day. Made to order (MTO) - see product category for specific lead time information. Products purchased in less than full inner carton quantities are subject to a \$75 broken carton charge, per destination. Prices effective March 9, 2020. Prices/stocking locations subject to change w/o notice. Refer to www.zebra.com.

Wristbands

Wristband Cartridges

Z-Band UltraSoft - Bracelet Design

Ultra-soft and flexible direct thermal polypropylene and vinyl wristband with an adhesive tamper-evident tab for securement. The bracelet design provides superior patient comfort by reducing the size of the wristband on the back of the wrist. Scannable up to 14 days. Wristbands contained in an easy-to-load cartridge for the HC100/ZD510 Printer.

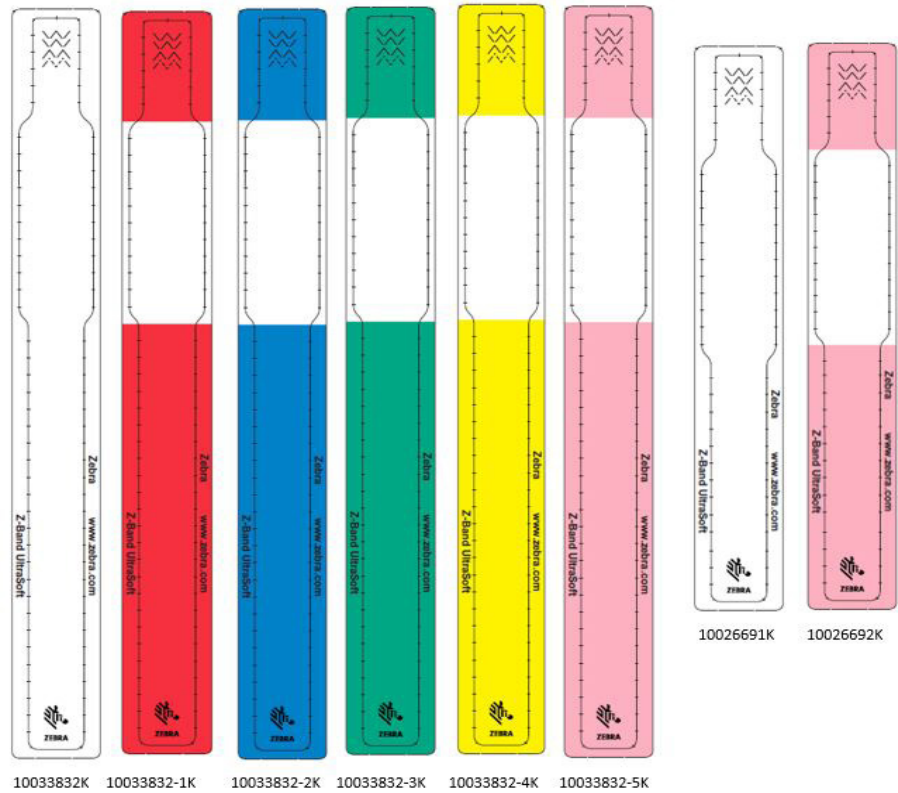

Size			Part #	Color	Amount/roll	Rolls/carton	Carton Weight	Stock/MTO	Price/kit
W	x	L							
1	x	7	10026691K	White	275	6	6 lbs.	Stock	\$417.24
1	x	7	10026692K	Pink	275	6	6 lbs.	Stock	\$433.74
1	x	10.75	10033832K	White	175	6	6 lbs.	Stock	\$298.79
1	x	10.75	10033832-1K	Red	175	6	6 lbs.	Stock	\$327.29
1	x	10.75	10033832-2K	Blue	175	6	6 lbs.	Stock	\$327.29
1	x	10.75	10033832-3K	Green	175	6	6 lbs.	Stock	\$327.29
1	x	10.75	10033832-4K	Yellow	175	6	6 lbs.	Stock	\$327.29
1	x	10.75	10033832-5K	Pink	175	6	6 lbs.	Stock	\$327.29

All wristband part numbers are perforated
With the gutter, wristband sizes are 1.1875"x7.25" and 1.1875"x11"

Stock - ships within one business day. Made to order (MTO) - see product category for specific lead time information.
Products purchased in less than full inner carton quantities are subject to a \$75 broken carton charge, per destination.
Prices effective March 9, 2020. Prices/stocking locations subject to change w/o notice. Refer to www.zebra.com.

Wristbands

Wristband Cartridges

Z-Band Direct Kit

Direct thermal polypropylene wristband with an adhesive tamper-evident tab for securement. Scannable up to 14 days. Wristbands contained in an easy-to-load cartridge for the HC100/ZD510 printer.

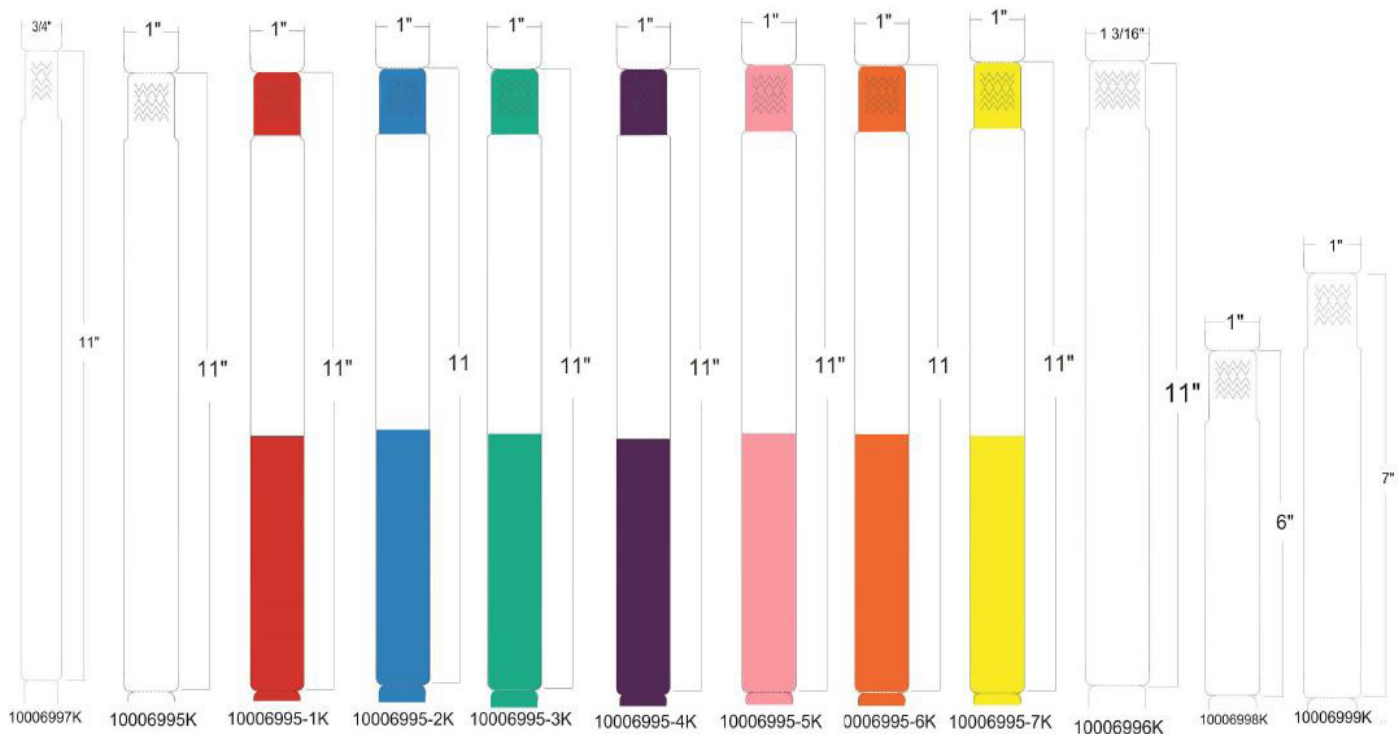

Size			Part #	Color	Amount/roll	Rolls/carton	Carton Weight	Stock/ MTO	Price/kit
W	x	L							
0.75	x	11	10006997K	White	200	6	6 lbs.	Stock	\$291.45
1	x	11	10006995K	White	200	6	6 lbs.	Stock	\$291.45
1	x	11	10006995-1K	Red	200	6	6 lbs.	Stock	\$306.03
1	x	11	10006995-2K	Blue	200	6	6 lbs.	Stock	\$306.03
1	x	11	10006995-3K	Green	200	6	6 lbs.	Stock	\$306.03
1	x	11	10006995-4K	Purple	200	6	6 lbs.	Stock	\$306.03
1	x	11	10006995-5K	Pink	200	6	6 lbs.	Stock	\$306.03
1	x	11	10006995-6K	Orange	200	6	6 lbs.	Stock	\$306.03
1	x	11	10006995-7K	Yellow	200	6	6 lbs.	Stock	\$306.03
1.1875	x	11	10006996K	White	200	6	6 lbs.	Stock	\$291.45
1	x	6	10006998K	White	350	6	6 lbs.	Stock	\$432.43
1	x	7	10006999K	White	300	6	6 lbs.	Stock	\$380.16

Must be ordered in carton quantities. Each part number represents 1 carton.

Stock - ships within one business day. Made to order (MTO) - see product category for specific lead time information. Products purchased in less than full inner carton quantities are subject to a \$75 broken carton charge, per destination. Prices effective March 9, 2020. Prices/stocking locations subject to change w/o notice. Refer to www.zebra.com.

Wristbands

Wristband Cartridges

Z-Band Comfort Kit

Light-weight and flexible direct thermal polypropylene wristband with an adhesive tamper-evident tab for securement. Scannable up to 7 days. Wristbands contained in an easy-to-load cartridge for the HC100/ZD510 printer.

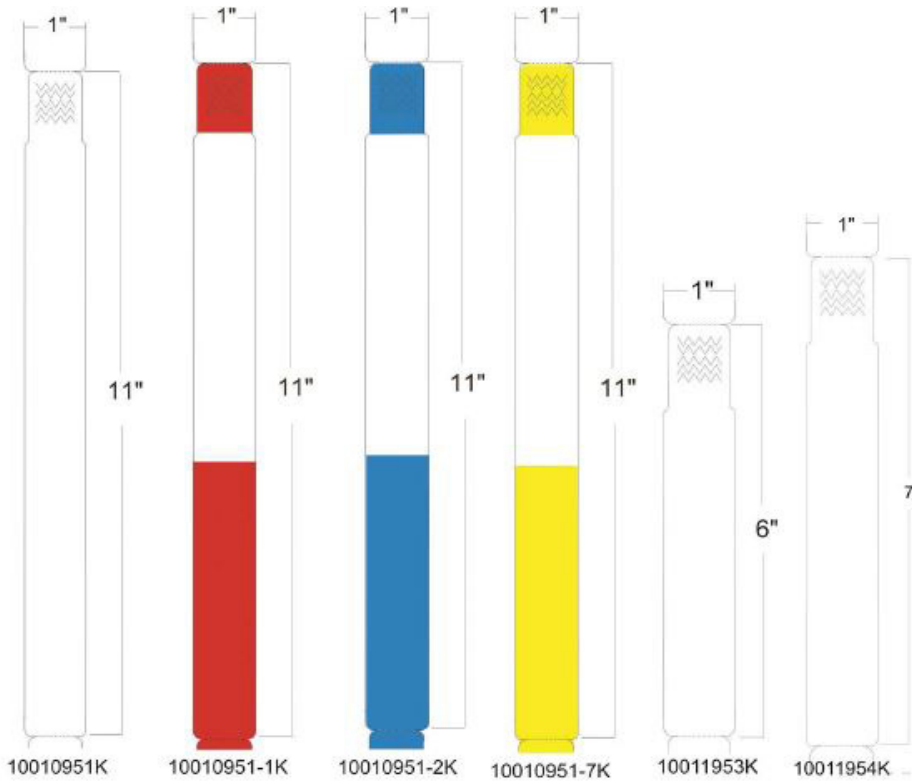

Size			Part #	Color	Amount/roll	Rolls/carton	Carton Weight	Stock/MTO	Price/kit
W	x	L							
1	x	11	10010951K	White	300	6	6 lbs.	Stock	\$437.18
1	x	11	10010951-1K	Red	300	6	6 lbs.	Stock	\$459.04
1	x	11	10010951-2K	Blue	300	6	6 lbs.	Stock	\$459.04
1	x	11	10010951-7K	Yellow	300	6	6 lbs.	Stock	\$459.04
1	x	6	10011953K	White	600	6	6 lbs.	Stock	\$741.31
1	x	7	10011954K	White	500	6	6 lbs.	Stock	\$633.60

Must be ordered in carton quantities. Each part number represents 1 carton.

Wristbands

Wristband Cartridges

Soft Infant Z-Band Direct Kit

A direct thermal white polypropylene wristband with soft nylon lining and an adhesive tab for securement. Wristbands contained in an easy-to-load cartridge for the HC100/ZD510 printer.

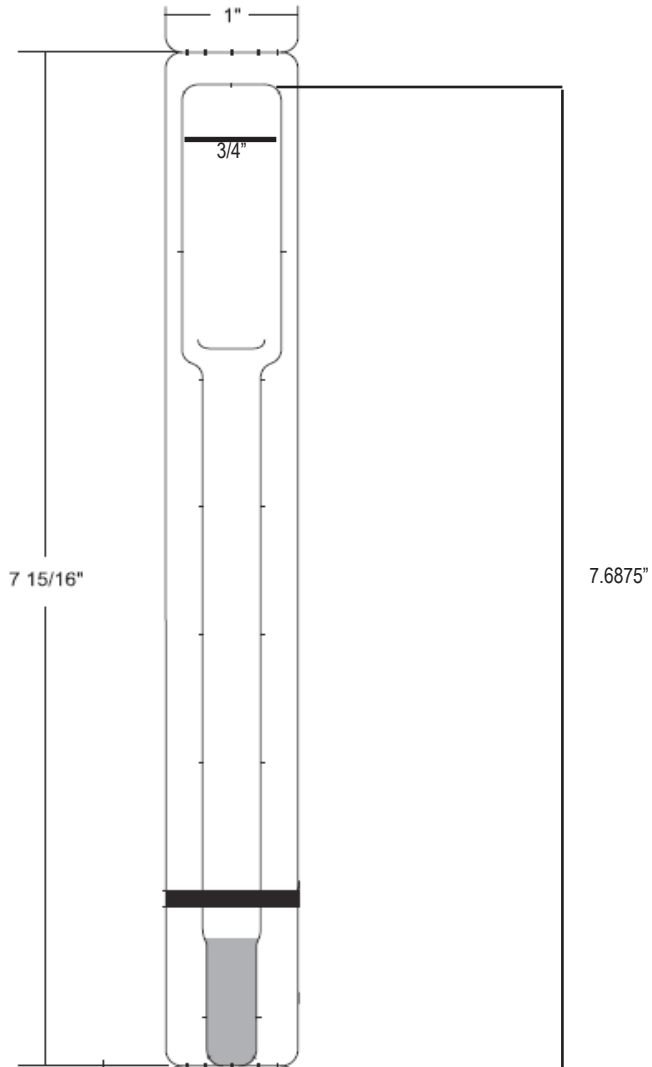

Size			Part #	Color	Amount/roll	Rolls/carton	Carton Weight	Stock/MTO	Price/kit
W	x	L							
0.75	x	7.6875	10031289K	White	260	6	5 lbs.	Stock	\$399.11

Wristband size is 1x7.9375 before tearing from gutter.
 Must be ordered in carton quantities. Each part number represents 1 carton.

Wristbands

Wristband Cartridges

Z-Band Quick Clip Kit

Direct thermal polypropylene wristband with secure clip closures. Scannable up to 14 days. Wristband contained in an easy-to-load cartridge for the HC100/ZD510 printer.

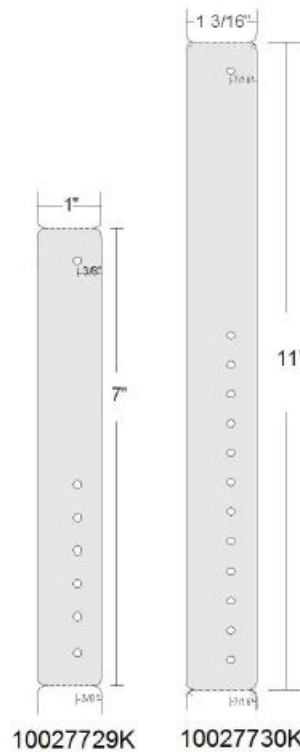

Size			Part #	Color	Amount/roll	Rolls/carton	Carton Weight	Stock/MTO	Price/kit
W	x	L							
1.1875	x	11	10027730K	White	240	4	6 lbs.	Stock	\$273.72
1	x	7	10027729K	White	380	3	6 lbs.	Stock	\$274.47

(1x7) Quickclip: Includes 3 wristband cartridges and 1,450 white clips. Color clips sold separately.
 (1.1875x11) Quickclip: Includes 4 wristband cartridges and 1,160 white clips. Color clips sold separately.

Color Clips for use with QuickClip Wristbands

Part #	Color	Clips Per Pack	Stock/MTO	Price/pack
97032-Blue	Blue	275	Stock	\$5.06
97032-Green	Green	275	Stock	\$5.06
97032-Pink	Pink	275	Stock	\$5.06
97032-Purple	Purple	275	Stock	\$5.06
97032-Red	Red	275	Stock	\$5.06
97032-Yellow	Yellow	275	Stock	\$5.06

Stock - ships within one business day. Made to order (MTO) - see product category for specific lead time information.
 Products purchased in less than full inner carton quantities are subject to a \$75 broken carton charge, per destination.
 Prices effective March 9, 2020. Prices/stocking locations subject to change w/o notice. Refer to www.zebra.com.

Wristbands

Z-Band UltraSoft

Z-Band UltraSoft Wristbands

Ultra-soft and flexible direct thermal polypropylene and vinyl wristband with an adhesive tamper-evident tab for securement. Scannable up to 14 days.

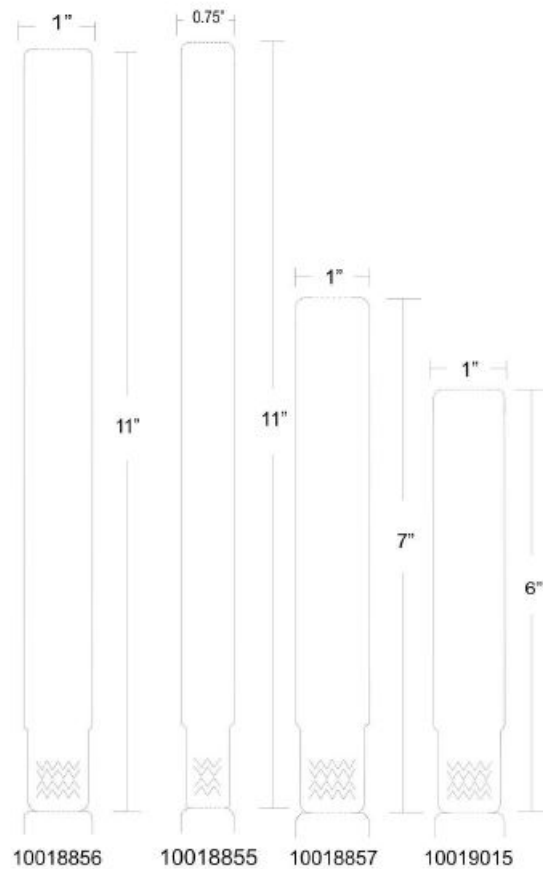

Size			Part #	ID, OD	Color	Amount/ roll	Rolls/ carton	Carton Weight	Stock/ MTO	Price/roll
W	x	L								
0.75	x	11	10018855	1" ID, 5" OD	White	175	6	6 lbs.	Stock	\$48.05
1	x	11	10018856	1" ID, 5" OD	White	175	6	6 lbs.	Stock	\$48.05
1	x	7	10018857	1" ID, 5" OD	White	250	6	6 lbs.	Stock	\$60.72
1	x	6	10019015	1" ID, 5" OD	White	300	6	6 lbs.	Stock	\$71.28

Stock - ships within one business day. Made to order (MTO) - see product category for specific lead time information. Products purchased in less than full inner carton quantities are subject to a \$75 broken carton charge, per destination. Prices effective March 9, 2020. Prices/stocking locations subject to change w/o notice. Refer to www.zebra.com.

Wristbands

Z-Band Direct

Z-Band Direct Wristbands

Direct thermal polypropylene wristbands with an adhesive tamper-evident for securement. Scannable up to 14 days.

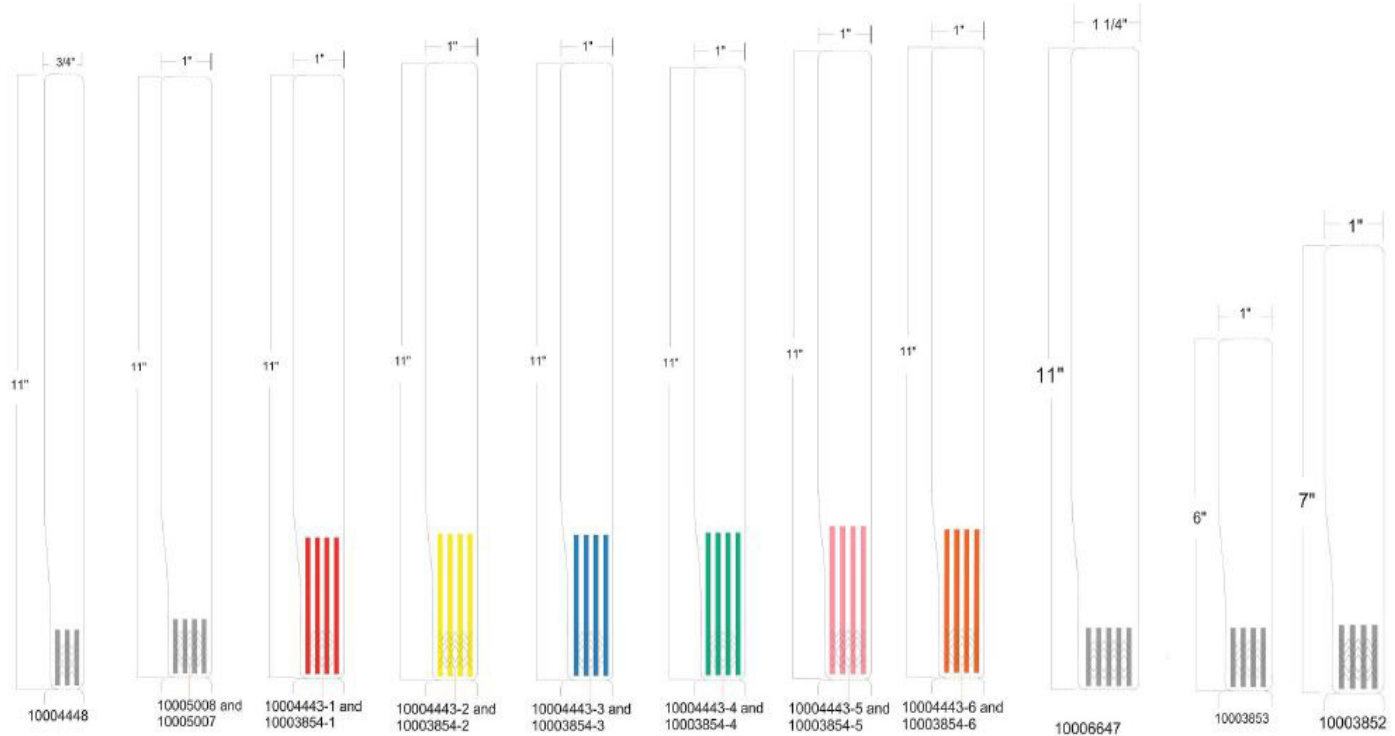

Size			Part #	ID, OD	Color	Amount/ roll	Rolls/ carton	Carton Weight	Stock/ MTO	Price/roll
W	x	L								
0.75	x	11	10004448	1" ID, 5" OD	White	200	6	4.8 lbs.	Stock	\$48.57
1	x	11	10005008	1" ID, 5" OD	White	200	6	4.8 lbs.	Stock	\$48.57
1	x	11	10005007	3" ID, 8" OD	White	450	6	9 lbs.	Stock	\$109.29
1	x	11	10004443-1	1" ID, 5" OD	Red	200	6	4.8 lbs.	Stock	\$51.00
1	x	11	10003854-1	3" ID, 8" OD	Red	450	6	9 lbs.	MTO	\$114.78
1	x	11	10004443-2	1" ID, 5" OD	Yellow	200	6	4.8 lbs.	Stock	\$51.00
1	x	11	10003854-2	3" ID, 8" OD	Yellow	450	6	9 lbs.	MTO	\$114.78
1	x	11	10004443-3	1" ID, 5" OD	Blue	200	6	4.8 lbs.	Stock	\$51.00
1	x	11	10003854-3	3" ID, 8" OD	Blue	450	6	9 lbs.	MTO	\$114.78
1	x	11	10004443-4	1" ID, 5" OD	Green	200	6	4.8 lbs.	Stock	\$51.00
1	x	11	10003854-4	3" ID, 8" OD	Green	450	6	9 lbs.	MTO	\$114.78
1	x	11	10004443-5	1" ID, 5" OD	Pink	200	6	4.8 lbs.	Stock	\$51.00
1	x	11	10003854-5	3" ID, 8" OD	Pink	450	6	9 lbs.	MTO	\$114.78
1	x	11	10004443-6	1" ID, 5" OD	Orange	200	6	4.8 lbs.	Stock	\$51.00
1	x	11	10003854-6	3" ID, 8" OD	Orange	450	6	9 lbs.	MTO	\$114.78
1.25	x	11	10006647	1" ID, 5" OD	White	200	6	4.8 lbs.	Stock	\$48.57
1	x	6	10003853	1" ID, 5" OD	White	350	6	4.8 lbs.	Stock	\$72.07
1	x	7	10003852	1" ID, 5" OD	White	300	6	4.8 lbs.	Stock	\$63.36

Stock - ships within one business day. Made to order (MTO) - see product category for specific lead time information.
 Products purchased in less than full inner carton quantities are subject to a \$75 broken carton charge, per destination.
 Prices effective March 9, 2020. Prices/stocking locations subject to change w/o notice. Refer to www.zebra.com.

Wristbands

Z-Band Fusion

Z-Band Fusion Wristbands: 3" ID, 8" OD

Self-laminating direct thermal polypropylene wristband with an adhesive closure and a wristband extender to fit a wide range of wrist sizes. Scannable up to 60 days.



FID-ADULT-L3-3-500T

Size			Part #	ID, OD	Color	Amount/ roll	Rolls/ carton	Carton Weight	Stock/ MTO	Price/roll
W	x	L								
2.75	x	0.875	FID-ADULT-L3-3-500T	3" ID, 8" OD	White	500	2	7 lbs.	Stock	\$284.3

All Z-Band fusion part numbers are perforated.

Wristbands

Z-Band Fusion

Z-Band Fusion Wristbands: 1" ID, 5" OD

Self-laminating direct thermal polypropylene wristband with an adhesive closure and a wristband extender to fit a wide range of wrist sizes. Scannable up to 60 days.

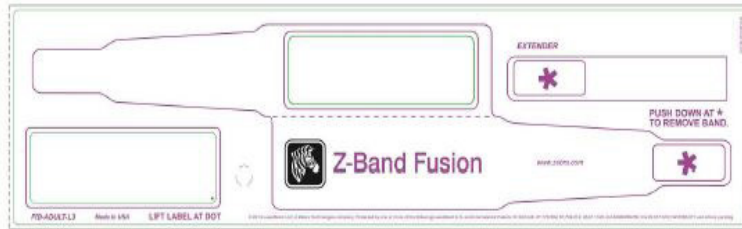

FID-ADULT-L3-1-200T
FID-ADULT-L3-3-500T



FID-PED-L3-1-200T



FID-BABY-L3-1-200T

Image Size			Part #	ID, OD	Color	Amount/ roll	Rolls/ carton	Carton Weight	Stock/ MTO	Price/roll
W	x	L								
2.75	x	0.875	FID-ADULT-L3-1-200T	1" ID, 5" OD	White	200	5	7 lbs.	Stock	\$295.67
2.75	x	0.875	FID-PED-L3-1-200T	1" ID, 5" OD	White	200	5	8 lbs.	Stock	\$211.66
1.63	x	0.750	FID-BABY-L3-1-200T	1" ID, 5" OD	White	200	5	8 lbs.	Stock	\$212.61

All Z-Band fusion part numbers are perforated.

Wristbands

Z-Band Fusion

Z-Band Fusion Infant ID Tags

Self-laminating direct thermal polypropylene infant tags, perfect for use in the NICU where the average infant stay exceeds 14 days. Can be used in conjunction with the ComfyCuff foam wristband, SwaddleBand, and Vinyl Infant Wristband Solution. Latex-free.



FID-BABY-T-1-500
FID-BABY-T-3-1M

Size			Part #	ID, OD	Color	Amount/ roll	Rolls/ carton	Carton Weight	Stock/ MTO	Price/roll
W	x	L								
1.75	x	0.875	FID-BABY-T-1-500	1" ID, 5" OD	White	500	2	7 lbs.	Stock	\$152.54
1.75	x	0.875	FID-BABY-T-3-1M	3" ID, 8" OD	White	1,000	1	7 lbs.	Stock	\$152.54

All Z-Band fusion part numbers are perforated.

Wristbands

Quick Clip

Z-Band Quick Clip Kit

Direct thermal polypropylene wristband with secure clip closures. Scannable up to 14 days.

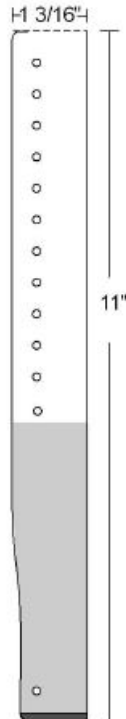

97890K and
10027728K

Size			Part #	ID, OD	Color	Amount/ roll	Rolls/ carton	Carton Weight	Stock/ MTO	Price/roll
W	x	L								
1.1875	x	11	10027728K	1" ID, 5" OD	White	240	6	11 lbs.	Stock	\$410.56
1.1875	x	11	97890K	3" ID, 8" OD	White	550	6	11 lbs.	Stock	\$940.89

PN 10027728K (1.1875x11) Includes 6 rolls of perforated wristbands and 1,740 white clips. Color clips sold separately.
 PN 97890 (1.1875x11) Includes 6 rolls of perforated wristbands and 3,480 white clips. Color clips sold separately.

Color Clips for use with QuickClip Wristbands

Part #	Color	Clips Per Pack	Stock/MTO	Price/pack
97032-Blue	Blue	275	Stock	\$5.06
97032-Green	Green	275	Stock	\$5.06
97032-Pink	Pink	275	Stock	\$5.06
97032-Purple	Purple	275	Stock	\$5.06
97032-Red	Red	275	Stock	\$5.06
97032-Yellow	Yellow	275	Stock	\$5.06

Stock - ships within one business day. Made to order (MTO) - see product category for specific lead time information.
 Products purchased in less than full inner carton quantities are subject to a \$75 broken carton charge, per destination.
 Prices effective March 9, 2020. Prices/stocking locations subject to change w/o notice. Refer to www.zebra.com.

Wristbands

Infant

Soft Infant Wristband

A direct thermal white polypropylene wristband with soft nylon lining with a t-shaped adjustable design, flat surface print area and an adhesive tab for securement.

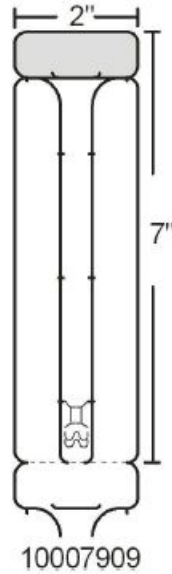

Size			Part #	ID, OD	Color	Amount/ roll	Rolls/ carton	Carton Weight	Stock/ MTO	Price/roll
W	x	L								
2	x	7	10007909	1" ID, 5" OD	White	275	6	6 lbs.	Stock	\$70.34

Stock - ships within one business day. Made to order (MTO) - see product category for specific lead time information.
 Products purchased in less than full inner carton quantities are subject to a \$75 broken carton charge, per destination.
 Prices effective March 9, 2020. Prices/stocking locations subject to change w/o notice. Refer to www.zebra.com.

Wristbands

RFID Wristbands

Z-Band Direct SR (Short Range)

Zebra's RFID wristband is ideal for use cases where the wristband is in close proximity to the reader, such as at the bedside through blankets or during a patient's surgery through the drape to quickly associate supplies and equipment used

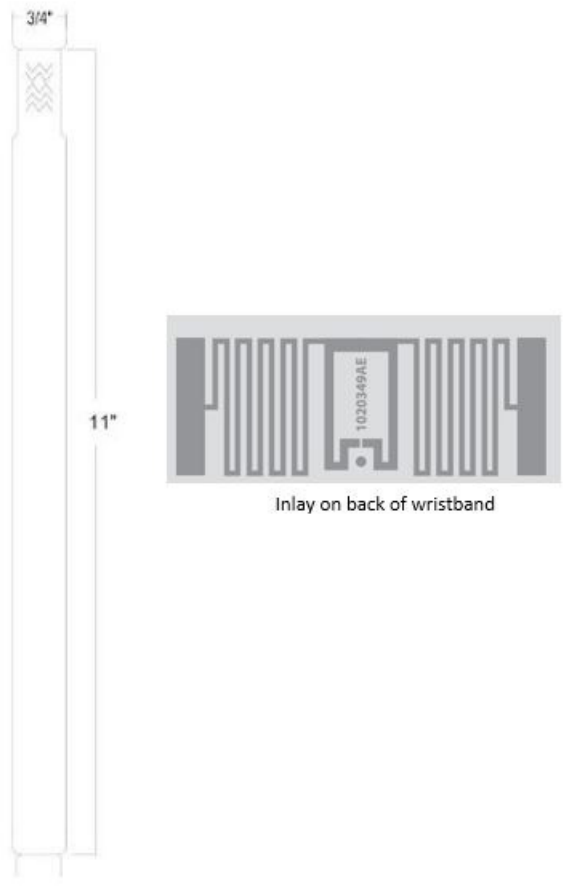

1" ID, 5" OD
Direct Thermal RFID Wristbands
For use with Zebra's ZD500R printer.

Size			Part #	Perf.	Inlay	Antenna/Chip	Material	Labels/ roll	Rolls/ case	Case Weight	Price/ roll	Price/ label	Stock Locations	
W	x	L											WI	GA
1	x	11	3014578	X	BT0600	UCODE 8	Z-Band Direct	175	3	3 lbs.	\$158.2	\$0.904	X	

Stock - ships within one business day. Made to order (MTO) - see product category for specific lead time information.
Products purchased in less than full inner carton quantities are subject to a \$75 broken carton charge, per destination.
Prices effective March 9, 2020. Prices/stocking locations subject to change w/o notice. Refer to www.zebra.com.

Wristbands

RFID Wristbands

Z-Band UltraSoft LR (Long Range)

Zebra’s Z-Band UltraSoft LR Wristband is uniquely designed with a specialty inlay designed for use against the human body. The design allows the wristband to flag away from the body, enabling longer read ranges. Ideal for use when over-head readers or portals are being used to provide best last known location tracking abilities.



1” ID, 5” OD

Direct Thermal RFID Wristbands

For use with Zebra’s ZD500R printer.

Size			Part #	Perf.	Inlay	Antenna/Chip	Material	Labels/roll	Rolls/case	Case Weight	Price/roll	Price/label	Stock Locations	
W	x	L											WI	GA
1	x	14	ZIPRD3015155	X	Zebra ZBR2002	UCODE 8	Z-Band UltraSoft	175	3	3 lbs.	\$271.20	\$1.550	X	

*Wristband measures 1.1875” x 14.25” before gutter is removed.

Wristbands - Non-printable

Alert Solutions

Spot Alert Labels

Spot-alert color-coded labels can be adhered to any Zebra wristband and feature a strong tamper-evident adhesive that causes the label to tear if tampered with. Available in standard color and designation combinations to support the most critical patient conditions.

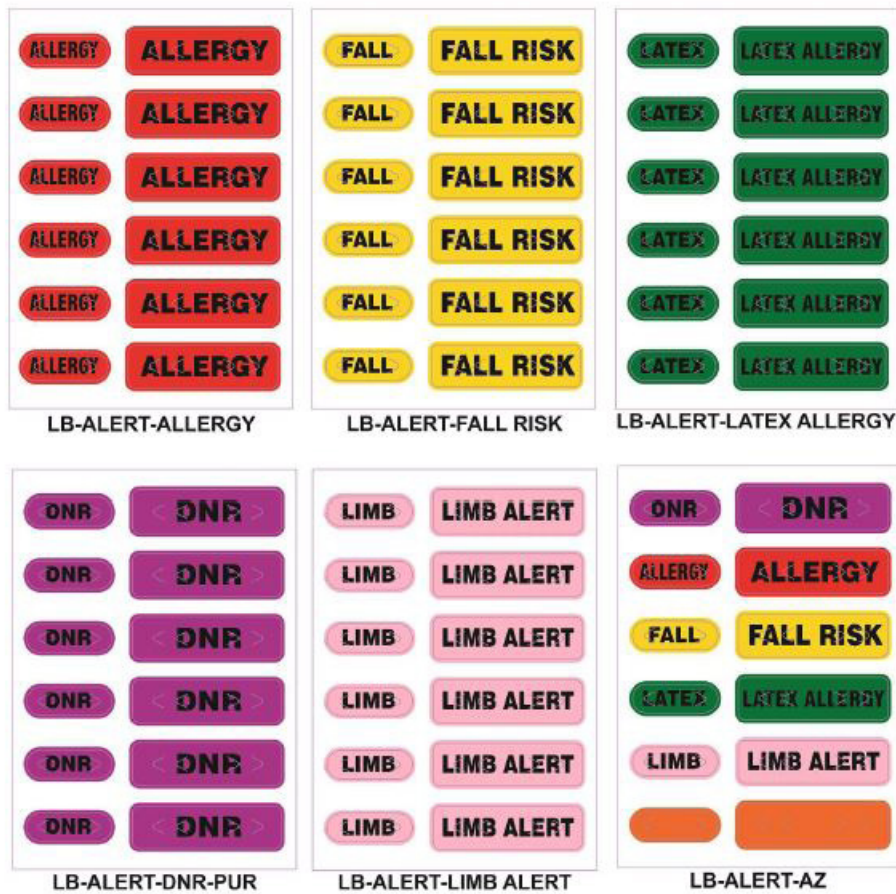

Size			Part #	Alert Designation	Color	Labels/ form	Forms/ case	Case Weight	Stock/ MTO	Price/ case
W	x	L								
2.5	x	3.5	LB-ALERT-ALLERGY	ALLERGY	Red	12	1,000	3 lbs.	Stock	\$69.02
2.5	x	3.5	LB-ALERT-FALLRISK	FALL RISK	Yellow	12	1,000	3 lbs.	Stock	\$69.02
2.5	x	3.5	LB-ALERT-DNR-PUR	DNR	Purple	12	1,000	3 lbs.	Stock	\$69.02
2.5	x	3.5	LB-ALERT-LATEXALLERGY	LATEX ALLERGY	Green	12	1,000	3 lbs.	Stock	\$69.02
2.5	x	3.5	LB-ALERT-LIMBALERT	LIMB ALERT	Pink	12	1,000	3 lbs.	Stock	\$69.02
2.5	x	3.5	LB-ALERT-AZ	ALL	All	12	1,000	3 lbs.	Stock	\$69.02

Each sheet contains (6) labels sized 1.3125" x 0.375" and (6) labels sized 0.75" x 0.25".

Stock - ships within one business day. Made to order (MTO) - see product category for specific lead time information. Products purchased in less than full inner carton quantities are subject to a \$75 broken carton charge, per destination. Prices effective March 9, 2020. Prices/stocking locations subject to change w/o notice. Refer to www.zebra.com.

Wristbands - Non-printable

Alert Solutions

Slim Alert Wristbands

Pre-printed vinyl wristbands with an integrated clip closure. Available in standard color and designation combinations to support the most critical patient conditions.

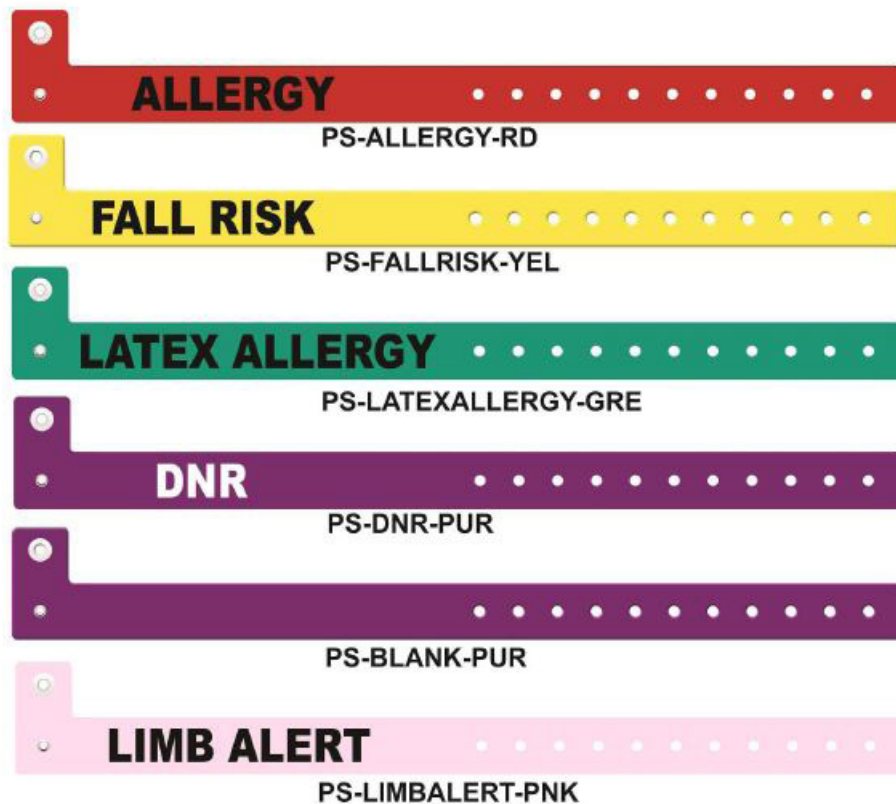

Size			Part #	Alert Designation	Color	Bands/ case	Case Weight	Stock/ MTO	Price/case
W	x	L							
0.625	x	10	PS-ALLERGY-RED	ALLERGY	Red	500	3 lbs.	Stock	\$95.34
0.625	x	10	PS-FALLRISK-YEL	FALL RISK	Yellow	500	3 lbs.	Stock	\$95.34
0.625	x	10	PS-DNR-PUR	DNR	Purple	500	3 lbs.	Stock	\$95.34
0.625	x	10	PS-LATEXALLERGY-GRE	LATEX ALLERGY	Green	500	3 lbs.	Stock	\$95.34
0.625	x	10	PS-LIMBALERT-PNK	LIMB ALERT	Pink	500	3 lbs.	Stock	\$95.34
0.625	x	10	PS-BLANK-PUR	BLANK	Purple	500	3 lbs.	Stock	\$95.34

Stock - ships within one business day. Made to order (MTO) - see product category for specific lead time information.
 Products purchased in less than full inner carton quantities are subject to a \$75 broken carton charge, per destination.
 Prices effective March 9, 2020. Prices/stocking locations subject to change w/o notice. Refer to www.zebra.com.

Wristbands - Non-printable

Alert Solutions

Tyvek Alert Wristbands

Color-coded Tyvek® alert wristbands with a tamper-evident adhesive closure. Available in standard color and designation combinations to support the most critical patient conditions.

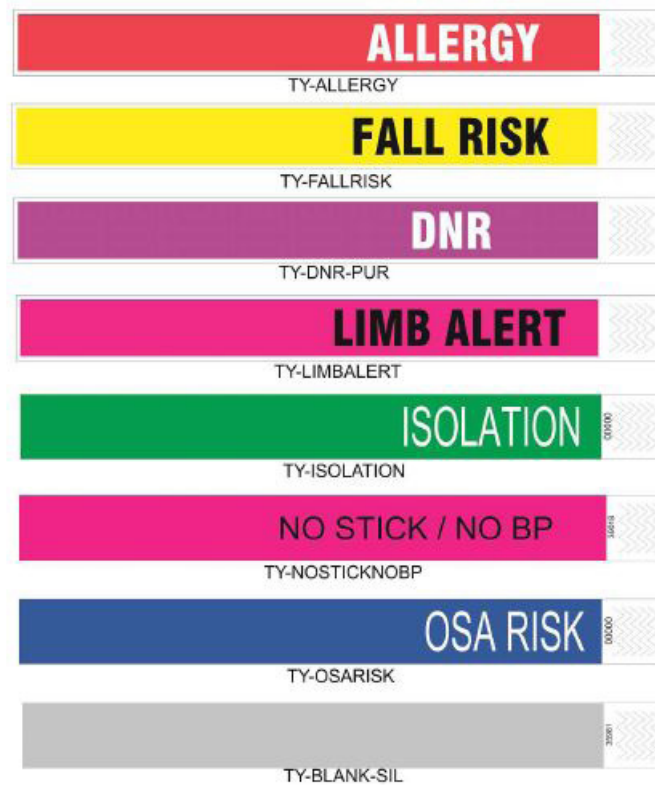

Size			Part #	Alert Designation	Color	Bands/ case	Case Weight	Stock/ MTO	Price/case
W	x	L							
1	x	10	TY-ALLERGY	ALLERGY	Red	1000	2 lbs.	Stock	\$62.51
1	x	10	TY-FALLRISK	FALL RISK	Yellow	1000	2 lbs.	Stock	\$62.51
1	x	10	TY-DNR-PUR	DNR	Purple	1000	2 lbs.	Stock	\$62.51
1	x	10	TY-LIMBALERT	LIMB ALERT	Pink	1000	2 lbs.	Stock	\$62.51
1	x	10	TY-ISOLATION	ISOLATION	Green	1000	2 lbs.	Stock	\$62.51
1	x	10	TY-NOSTICKNOBP	NO NEEDLES/NO BP	Pink	1000	2 lbs.	Stock	\$62.51
1	x	10	TY-OSARISK	OSA RISK	Blue	1000	2 lbs.	Stock	\$62.51
1	x	10	TY-BLANK-SIL	BLANK	Silver	1000	2 lbs.	Stock	\$62.51

Stock - ships within one business day. Made to order (MTO) - see product category for specific lead time information.
 Products purchased in less than full inner carton quantities are subject to a \$75 broken carton charge, per destination.
 Prices effective March 9, 2020. Prices/stocking locations subject to change w/o notice. Refer to www.zebra.com.

Wristbands - Non-printable

OmniBand

OmniBand

Self-laminating wristband with a tamper evident adhesive closure that can be used in conjunction with virtually any printing label. Includes wristband extender to fit a wide variety of wrist sizes.

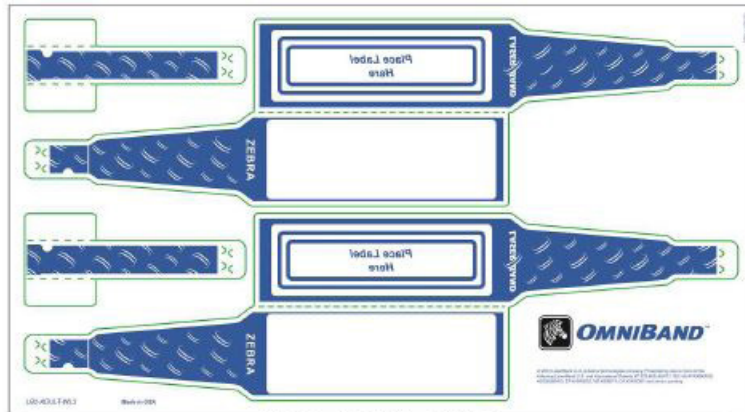

LB2-ADULT-WL3

Available in white, red, blue and orange

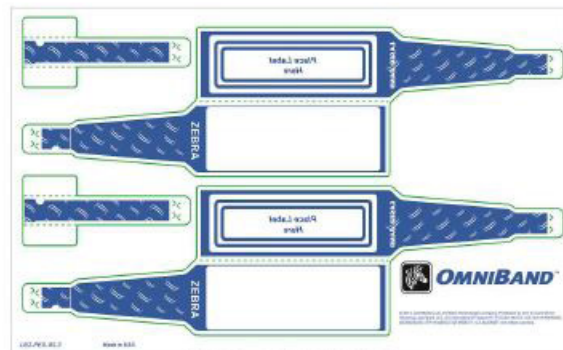

LB2-PED-WL3

Available in white

Max Label Size			Part #	Wristband Length	Extender Length	Color	Bands/ case	Case Weight	Stock/ MTO	Price/case
W	x	L								
3.25	x	1	LB2-ADULT-WL3	10	3.25	White	1000	10 lbs.	Stock	\$131.49
3.25	x	1	LB2-ADULT-WL3-RED	10	3.25	Red	1000	10 lbs.	MTO	\$131.49
3.25	x	1	LB2-ADULT-WL3-BLU	10	3.25	Blue	1000	10 lbs.	Stock	\$131.49
3.25	x	1	LB2-ADULT-WL3-ORA	10	3.25	Orange	1000	10 lbs.	Stock	\$131.49
2.25	x	0.75	LB2-PED-WL3	8	2.625	White	1000	7 lbs.	Stock	\$148.02

Sheet measures 4.25" x 11".

500 sheets/case containing (2) wristbands and (2) extenders each.

Stock - ships within one business day. Made to order (MTO) - see product category for specific lead time information. Products purchased in less than full inner carton quantities are subject to a \$75 broken carton charge, per destination. Prices effective March 9, 2020. Prices/stocking locations subject to change w/o notice. Refer to www.zebra.com.

Wristbands - Non-printable

Vinyl Infant Wristband Solutions

Vinyl Infant Wristband Solutions

Soft, flexible vinyl wristbands for use with the Z-Band Fusion Infant ID Tags. The narrow width allows some models of “Abduction Prevention Systems” to be attached. Available in clip or self-locking closure. Self-locking closure can be adjusted with a gentle tug as the infant loses mass around the wrists and ankles within the first 24 hours of birth. Latex-free.



PS-BABY



PS-INFANT-ADJ

* PS-BABY and PS-INFANT-ADJ are pictured with Z-Band Fusion Infant ID Tags.

Max Label Size			Part #	Closure Style	Color	Bands/case	Case Weight	Stock/ MTO	Price/case
W	x	L							
0.39	x	6.25	PS-BABY	Clip	White	250	1 lb.	Stock	\$54.54
0.39	x	8.5	PS-INFANT-ADJ	Self-Locking	White	250	1 lb.	Stock	\$73.86

Wristbands - Non-printable

ComfyCuff Solution

ComfyCuff

Soft foam cuff featuring an adjustable Velcro® closure ensuring infant comfort. Can be used in conjunction with Z-Band Fusion Infant ID tags, ComfyCuff Infant SwaddleBand and ComfyCuff Security Seal.



LB2-BABY-P

*Pictured with Z-Band Fusion Infant ID Tag

Size			Part #	Color	Bands/case	Case Weight	Stock/MTO	Price/case
W	x	L						
1.375	x	5.5	LB2-BABY-P	White	100	1 lb.	Stock	\$115.73

ComfyCuff Security Seal

Label designed to securely stick to the ComfyCuff material and self-destruct to indicate wristband tampering. Latex-free.



LB2-BABY-CCS

*Pictured with LB2-BABY-P (ComfyCuff) and Z-Band Fusion Infant ID Tag

Size			Part #	Color	Bands/case	Case Weight	Stock/MTO	Price/case
W	x	L						
2.875	x	0.4375	LB2-BABY-CCS	White	1000	1 lb.	Stock	\$38.98

Wristbands - Non-printable

ComfyCuff Solution

ComfyCuff Infant Swaddle Band

ComfyCuff Infant Swaddleband makes identifying a swaddles infant quick and easy. The Swaddleband creates an extension between the ComfyCuff and Z-Band Fusion Infant ID Tags or wristband, allowing the tag to be easily accessible. Available in Tyvek® (LB2-Baby-SWB). Latex-free.



LB2-BABY-SWB9

*Pictured with ComfyCuff and Z-Band Fusion Infant ID Tags

Size			Part #	Color	Bands/case	Case Weight	Stock/MTO	Price/case
W	x	L						
0.25	x	6	LB2-BABY-SWB	White	250	1 lb.	Stock	\$93.22
0.41	x	9	LB2-BABY-SWB9	White	500	1 lb.	Stock	\$93.22

Stock - ships within one business day. Made to order (MTO) - see product category for specific lead time information. Products purchased in less than full inner carton quantities are subject to a \$75 broken carton charge, per destination. Prices effective March 9, 2020. Prices/stocking locations subject to change w/o notice. Refer to www.zebra.com.

Ribbons

6100 Wax/Resin

Part Number	Formulation	Width		Length		Quantity Per		Outer Box Weight	Stock/ MTO	Price/ roll	Printer Type
		inches	mm	feet	m	Carton	Outer Box				
06100GS06407	Wax/Resin	2.52"	64mm	243'	74m	48	48	9 lbs.	Stock	\$3.33	Desktop
06100BK06045	Wax/Resin	2.36"	60mm	1476'	450m	6	6	6 lbs.	Stock	\$17.14	Industrial
06100BK08045	Wax/Resin	3.15"	80mm	1476'	450m	6	6	7 lbs.	Stock	\$22.84	Industrial
06100BK11045	Wax/Resin	4.33"	110mm	1476'	450m	6	6	7 lbs.	Stock	\$31.41	Industrial

6200 Resin

Part Number	Formulation	Width		Length		Quantity Per		Outer Box Weight	Stock/ MTO	Price/ roll	Printer Type
		inches	mm	feet	m	Carton	Outer Box				
06200BK06045	Resin	2.36"	60mm	1476'	450m	6	6	6 lbs.	Stock	\$25.43	Industrial
06200BK08345	Resin	3.27"	83mm	1476'	450m	6	6	7 lbs.	Stock	\$35.20	Industrial
06200BK11045	Resin	4.33"	110mm	1476'	450m	6	6	7 lbs.	Stock	\$46.64	Industrial

5095 Resin

Part Number	Formulation	Width		Length		Quantity Per		Outer Box Weight	Stock/ MTO	Price/ roll	Printer Type
		inches	mm	feet	m	Carton	Outer Box				
05095BK110D	Resin	4.33"	110mm	98'	30m	10	10	2 lbs.	Stock	\$30.18	Mobile

Image Lock Resin

Part Number	Formulation	Width		Length		Quantity Per		Outer Box Weight	Stock/ MTO	Price/roll	Printer Type
		inches	mm	feet	m	Carton	Outer Box				
74941	Resin	2.52"	64mm	243'	74m	12	48	8 lbs.	MTO	\$31.76	Desktop
74943	Resin	4.33"	110mm	243'	74m	12	48	12 lbs.	MTO	\$54.58	Desktop

ZD420 Ribbon Cartridges

Part Number	Formulation	Width		Length		Quantity Per		Outer Box Weight	Stock/ MTO	Price/ roll	Printer Type
		inches	mm	feet	m	Carton	Outer Box				
02000CT11007	Wax	4.33"	110mm	243'	74m	6	6	3 lbs.	Stock	\$11.93	ZD420 Only
05095CT11007	Resin	4.33"	110mm	243'	74m	6	6	2 lbs.	Stock	\$23.81	ZD420 Only
05555CT11007	Wax/Resin	4.33"	110mm	243'	74m	6	6	3 lbs.	Stock	\$14.12	ZD420 Only
74783	Resin	4.33"	110mm	243'	74m	6	6	2 lbs.	Stock	\$66.15	ZD420 Only

Stock - ships within one business day. Made to order (MTO) - see product category for specific lead time information.
 Products purchased in less than full inner carton quantities are subject to a \$75 broken carton charge, per destination.
 Prices effective March 9, 2020. Prices/stocking locations subject to change w/o notice. Refer to www.zebra.com.